



Fraunhofer

IESE

FRAUNHOFER INSTITUTE FOR EXPERIMENTAL SOFTWARE ENGINEERING IESE

ANNUAL REPORT 2012/2013



THE FRAUNHOFER INSTITUTE FOR EXPERIMENTAL SOFTWARE ENGINEERING IESE

Fraunhofer Institute for
Experimental Software
Engineering IESE
Fraunhofer-Platz 1
67663 Kaiserslautern
Germany

Phone +49 631 6800-6000
Fax +49 631 6800-1099

www.iese.fraunhofer.de

Executive Director
Prof. Dr. Dr. h. c.
Dieter Rombach

Scientific Director
Prof. Dr.-Ing.
Peter Liggesmeyer

Software is a part of our lives. Embedded into everyday equipment, into living and working environments or modern means of transportation, countless processors and controllers make our lives simpler, safer, and more pleasant. We help organizations to develop software systems that are reliable in every aspect, and provide empirical proof of the necessary processes, methods, and techniques, emphasizing engineering-style principles such as measurability and transparency.

Fraunhofer IESE in Kaiserslautern is one of the worldwide leading research institutes in the area of software and systems engineering methods. A major portion of the products offered by its collaboration partners is defined by software. These products range from automotive and transportation systems via automation and plant engineering, information systems, health care and medical systems to software systems for the public sector. The solutions allow flexible scaling. This makes the institute a competent technology partner for organizations of any size – from small companies to major corporations.

Under the leadership of Prof. Dieter Rombach and Prof. Peter Liggesmeyer, Fraunhofer IESE has spent the last fifteen years making major contributions to strengthening the emerging IT hub Kaiserslautern. In the Fraunhofer Information and Communication Technology Group, it is cooperating with other Fraunhofer institutes on developing trend-setting key technologies for the future.

Fraunhofer IESE is one of 60 institutes of the Fraunhofer-Gesellschaft. Together they have a major impact on shaping applied research in Europe and contribute to Germany's competitiveness in international markets.

© 2013 Fraunhofer IESE

Editorial Notes

Editorial Board:

Dipl.-Dolmetscherin Sonnhild Namingha
(Editor-in-Chief)

Dipl.-Betriebswirtin (BA) Nicole Spanier-Baro
(Head of PR / Marketing)

Translation:

Dipl.-Dolm. Sonnhild Namingha

Layout and Setting:

Dipl.-Betriebswirt (BA) Stephan Thiel

CD-ROM Production:

digiCon AG, Kornwestheim

Photo acknowledgments:

Fraunhofer IESE

Fraunhofer PR-Netzwerk

iStockphoto.com

John Deere (p. 77/95)

Airbus (p. 79)

Bundeswehr/Winges (p. 81)

This Annual Report is also available
in German.

CoBRA®, CROCODILE®, FAME®, GQM+Strategies®, NiXE®,
OSR®, PuLSE® and SPEARMINT® are registered trademarks of
Fraunhofer-Gesellschaft.

All other products and tradenames may be registered by their
respective owners. A lack of such indication does not imply
that a particular name is free of third-party rights.

EDITORIAL

INNOVATION AND COMPETITIVENESS FOR THE “DIGITAL SOCIETY 2.0”

Dear reader,

In all branches of industry as well as in our private lives and in society at large, innovations are increasingly driven by software. The most important future trend is convergence, meaning that isolated solutions for different control and/or information processing tasks will be replaced by integrated overall solutions.

The vision of a “Digital Society 2.0” is based on the assumption that in the future, all business, private, and social activities and services will be supported by software in an integrated manner and without changes in medium, and that additional, completely new synergies will be created through the integration of widely different applications (e.g., energy and health management). On the one hand, the goal is to reduce costs through convergence, for example if energy and health management at home make use of the same IT platforms. On the other hand, completely new functions and services shall be provided, such as the diagnosis of health problems based on deviations in the consumption of energy. New challenges regarding the software engineering of such deeply integrated systems arise with regard to bringing together security and safety and adhering to quality assurances despite dynamic adaptation of the systems at runtime. “Ambience” and “Emergence” are the catchwords that describe important preliminary research projects for the public sector in which we not only play a key role, but where we are driving the developments!

The development towards the “Digital Society 2.0” is happening in several steps. Starting with embedded software in products (e.g., automotive control software) and information systems (e.g., management systems for route determination), the real world and the digital information world are currently being united under the catchphrase “Cyber-Physical Systems (CPS)”. Logistics information systems, for example, can identify the current location of physical packages via so-called RFIDs

and initiate countermeasures, if necessary. A similar example is the gas usage control in automobiles, which can be optimized by accessing information from geographic information systems or traffic jam reports. In the next step, we are currently observing trends towards the complete integration of all software systems in specific ecosystems (e.g., health management) under the catchphrase “Smart Ecosystems (SES)”. In the smart ecosystem “Health”, for example, integrating medical devices, diagnosis systems, and accounting systems can lead to streamlining patient care and decreasing the number of mistakes made in this area. In particular, this integration also allows thinking about moving certain diagnoses and therapies from expensive hospitals to general practitioners or even completely into the patient’s home. The last step in the realization of the vision “Digital Society 2.0 (DG 2.0)” will be the integration of solutions across the boundaries of ecosystems. One example that is already being discussed today is the integration of energy and health management. On the one hand, huge installation costs can be saved if joint platforms are used. On the other hand, information originating from energy management can also be useful in diagnosing critical changes of a person’s health status.

If you want to stay ahead of your competitors, you will need innovative software and the leading software development expertise available in your domain. In the era of software convergence, the challenges are becoming ever greater. Dependable software requires professional development processes. Fraunhofer IESE is a competent and reliable partner for companies from all sectors of industry regarding the subject of “Software Engineering”. We offer dependable methods and tools for the software development of embedded systems and information systems – but also for the development of CPS and software for supporting entire ecosystems – as well as process know-how for the successful introduction of such methods and tools.



Building on our competencies in the area of cyber-physical systems, we increasingly directed our attention to the development of Smart Ecosystems including mobile end-devices in the past year. We are, for instance, helping manufacturers of agricultural machinery to test integrated support of agricultural workflows and to evaluate the resulting added value. In many other domains we are also supporting the trend towards Smart Ecosystems, e.g., in health care to facilitate communication between doctors, nurses, and patients; in production technology to make maintenance easier by using situation-related information; or among financial service providers to provide support for their sales representatives on the road.

In 2012, we drastically increased our preliminary research on the topic of "Smart Ecosystems" in the BMBF Software-Cluster "Software Innovations for the Digital Enterprise". Collaboration in this project is open to additional companies. In cooperation with the European Technology Innovation Center of the agricultural machinery manufacturer John Deere in Kaiserslautern, first applications are currently being tested in practice.

We have established an internal task force that is committed to merging empirical evidence about our core competencies and complementing these wherever necessary. This will help us to adapt our offers even better to company-specific require-

ments in the future, and will allow us to provide ROI estimates and decision support for the selection of new software engineering methods.

There is much that remains to be done. The rapid technological progress keeps presenting us with new challenges that we are eager to accept. We have many ideas for new projects with our collaboration partners and those wanting to cooperate with us in the future. IESE enjoys global visibility. This is reflected in the rising numbers of international collaborations with partners from science and industry. In the USA, Australia, and Brazil, we have already founded centers. You, too, can become a partner of IESE! Make use of our competence and benefit from our international network. We will support you on your way towards more innovation and competitiveness through dependable software!

We hope you find this report both informative and inspiring –

Dieter Rombach

Dieter Rombach

P. Liggesmeyer

Peter Liggesmeyer



Prof. Dr. Dieter Rombach



Prof. Dr. Peter Liggesmeyer

CONTENT

	PROFILE OF FRAUNHOFER IESE	9
	Highlights of the Year 2012	10
	Outlook on 2013	18
	The Fraunhofer-Gesellschaft	26
	Fraunhofer IESE and its Network Partners	28
	IESE in Fraunhofer Groups and Alliances	32
	Organizational Structure	40
	The Advisory Board	42
	Personnel and Budget	43
	BUSINESS AREAS	45
	Automotive and Transportation Systems	46
	Automation and Plant Engineering	48
	Medical Devices	50
	Information Systems	52
	eGovernment	54
	Health Care	56
	DEPARTMENTS	59
	Division Embedded Systems	61
	Division Process Management	65
	Division Information Systems	69
	PROJECTS	73
	DENSO: Control as a Service – How Suitable are the Technologies of Today for the Car of Tomorrow?	74
	JOHN DEERE: Efficient TIA Safety	76
	CESAR: Automatically Optimized Deployment of Software Functions to Flight Computers	78
	BUNDESWEHR: Systems Engineering for the Multi-Role Combat Ship 180	80
	Innovation Center Applied System Modeling: Cyber-Physical Systems	82
	Project Retrospectives	84
	ONKOPTI: Oncological Therapy Protocols on the Internet	86
	ARAMIS: Process Configuration Framework	88
	ICE-WISH: 15% Less Energy and Water Consumption through Innovative Information Technology	90
	INSIDERS TECHNOLOGIES: Joint Research & Development Lab	92
	JOHN DEERE: Secure Software Engineering for Embedded Systems	94
	proALPHA: Test Process Improvement with Metrics	96
	IBIS: Designing Intuitive Use with Image Schemata	98
	SOFTWARE-CLUSTER: The Next Generation of Enterprise Software	100

	Innovation Center Applied System Modeling: “Smart Farming” Living Lab	102
	FRAUNHOFER ACADEMY: Software Architecture Seminars – Expert Knowledge from the Source	104
	INTERNATIONAL ACTIVITIES	107
	Fraunhofer Center for Experimental Software Engineering CESE, Maryland	108
	Fraunhofer Project Center for Transport and Logistics in Australia	114
	Fraunhofer Project Center for Software and Systems Engineering in Brazil	116
	ECOPETROL: Software Quality Modeling in the Oil and Gas Domain	118
	JAXA: Evaluating the Quality of Safety-Critical Software Systems	120
	CONTACT	123
	How to find us	124
	Fraunhofer IESE Contact Persons	128
	Information Service	131
	APPENDIX	133
	Network in Science and Industry	134
	Professional Contributions	139
	Scientific Contributions	150
	Awards	161



PROFILE OF FRAUNHOFER IESE

Highlights of the Year 2012	10
Outlook on 2013	18
The Fraunhofer-Gesellschaft	26
Fraunhofer IESE and its Network Partners	28
IESE in Fraunhofer Groups and Alliances	32
Organizational Structure	40
The Advisory Board	42
Personnel and Budget	43

HIGHLIGHTS OF THE YEAR 2012

OPENING OF FRAUNHOFER PROJECT CENTER IN BRAZIL

On 9 March 2012, the opening ceremony of the first Fraunhofer Project Center (FPC) in Brazil took place in Salvador, Bahia. The ceremony was attended by the Executive Director of Fraunhofer IESE, Prof. Dr. Dieter Rombach, by the Lord Mayor of the City of Kaiserslautern, Dr. Klaus Weichel, and by various representatives of businesses from Kaiserslautern. On the Brazilian side, the attendees included the State Secretary for Science, Technology and Innovation of the state of Bahia, Paulo Camera, and the Director of the Project Center, Prof. Manoel Mendonça.

The Fraunhofer Project Center for Software and Systems Engineering is located in the Technology Park of Bahia, which hosts companies such as IBM, Portugal Telecom Innovation, and several big Brazilian companies. The new Fraunhofer Project Center will be active in the area of Software and Systems En-

gineering and will address topics such as innovative solutions for critical and/or large systems, mobile business applications, e-Government, and ambient assisted living. The center is a joint initiative of the Federal University of Bahia (UFBA) and the Fraunhofer-Gesellschaft in Germany. Brazil is the world's eighth-largest economy and one of the fastest-growing major economies. The country has a sophisticated technological sector, developing projects that range from submarines to aircraft, and is also a pioneer in many fields, including ethanol production and deep-water oil research. In terms of software technologies, Brazil was the first country in the world to have fully automated electronic elections. The establishment of the Fraunhofer Project Center at UFBA will bring the Fraunhofer-Gesellschaft into the Brazilian market for software and systems technologies.





COMMERCIAL VEHICLE EXPERTS MEET IN KAISERSLAUTERN

From 13 to 15 March 2012, the 2nd international Commercial Vehicle Symposium took place at the University of Kaiserslautern. The organizer was the Commercial Vehicle Alliance Kaiserslautern, a conglomerate of all organizations in Kaiserslautern that are doing research in the area of commercial vehicle technology or that are supporting such research. This also includes Fraunhofer IESE. The symposium is unique in the way it combines research and industry in an interdisciplinary manner. At the interdisciplinary event, state-of-the-art research results as well as innovative processes and products for trucks, buses, and agricultural and construction machinery were presented in more than 50 presentations during the course of three days.

At the opening of the industry exhibit on the night prior to the main event, the Rhineland-Palatinate Science Minister Doris Ahnen pointed out the successful alliance of the stakeholders in the region in the Commercial Vehicle Alliance (CVA): "Thanks to the bundling of activities (which was initiated by the Ministry of Science) between the University, the local Fraunhofer institutes, and the Commercial Vehicle Cluster in the CVA, there is now one central hub that creates even closer links between research and application. I am sure that the visibility of the Kaiserslautern region as the German and European hub for research and development in the area of commercial vehicles will continue to expand under this umbrella brand."

In her welcome address, Agriculture Minister Eveline Lemke also voiced her satisfaction with the development in Kaiser-

lautern in recent years. About the event, she said in retrospect: "The symposium with more than 250 participants from ten countries will increase the international visibility of the commercial vehicle hub Kaiserslautern. For our small and medium-sized supply industry, it is important to work on improving the overall environmental balance together with the commercial vehicle manufacturers and the science community. The network structure found in Kaiserslautern already offers an ideal platform for energy- and resource-efficient innovations and the improvement of the CO₂ balance of commercial vehicles. I hope that jointly we will manage to establish Rhineland-Palatinate and Kaiserslautern as a center where different actors collaborate on developing "efficient and clean" commercial vehicles." Additional welcome addresses were given by the president of the University of Kaiserslautern, Professor Helmut Schmidt, as well as the Senior Vice President Research Planning of the Fraunhofer-Gesellschaft, Professor Ulrich Buller.

The relevance of the commercial vehicle industry was demonstrated by Professor Thomas Herlitzius from the University of Dresden in his plenary presentation: Since global farmland is limited, feeding a world population of more than seven billion people is a major challenge. A solution can only be achieved by further increasing efficiency, which also needs to include the use of unconventional technical solutions. As an example, Herlitzius showed the concept of a novel type of combine, where a stationary threshing device is fed by several cutting tools that operate autonomously.



The complexity of developing a modern hybrid bus was shown by Dr. Eric Sax from Evobus in a plenary talk given by this representative from industry. The multitude of variants among customized buses, in particular, requires high-performance processes and methods in quality assurance. Safety and reliability are of paramount importance, especially for the European manufacturers.

The presentations covered a wide range of topics, from light-weight construction and durability, component and system simulation, electronics and software, via safety and reliability to environmental protection and emission reduction. A collection of the conference proceedings has been published by Shaker.

The next date for the biennial Commercial Vehicle Technology Symposium Kaiserslautern has already been set: It will take place from 11 to 13 March 2014.

The Commercial Vehicle Alliance Kaiserslautern is a conglomerate of regional competence carriers in the area of commercial vehicle technology. It consists of the Center for Commercial Vehicle Technology (ZNT) of the University of Kaiserslautern, the Fraunhofer Innovation Cluster "Digital Commercial Vehicle Technology" (DNT), and the Commercial Vehicle Cluster Südwest (CVC).



NON-STOP-GOVERNMENT

P23R WINS INNOVATION AWARD

“Public Service: Ideas for Everyone” – The Innovation Award of dbb beamtenbund und tarifunion 2012 went to the national project P23R | Prozess-Daten-Beschleuniger.

The award, with 50,000 euros among those with the highest prize money in Germany, is given for innovative public administration ideas and projects.

Under the leadership of the Fraunhofer-Gesellschaft für angewandte Forschung e.V., an interdisciplinary project team consisting of partners from business, science, and public administration was commissioned by the Federal Ministry of the Interior to develop the foundations for the design of reporting processes between companies and public administration without changes in medium.

Currently, there are more than 10,000 reporting obligations for companies in Germany, which place an annual burden of almost 40 billion euros on businesses. P23R aims at reducing this effort for both businesses and public administration.

The P23R principle developed by the project team ensures simple, safe, and fast data exchange between companies and public agencies. It includes an infrastructure concept that businesses can use as a basis for efficiently fulfilling their legal information and reporting obligations in a secure environment. As part of the application landscape in a company, solutions on the basis of P23R generate the required reports and then properly forward them to the appropriate public agencies.

“As an electronic interface between business and public administration, P23R greatly simplifies complex administrative processes. This allows combining and processing the data from both areas without changes in medium. P23R thus not only helps to accelerate complex administrative processes, but also to minimize administrative costs. The process data accelerator (P23R – Prozessdatenbeschleuniger) is therefore a real administrative innovation”, said dbb federal chairman Peter Heesen.

Prof. Reimund Neugebauer, President of the Fraunhofer-Gesellschaft, sees applied research as an important source of impulses for innovations in public administration:

“The P23R principle, which was developed under the leadership and with the participation of five institutes of the Fraunhofer-Gesellschaft, does not only make the handling of reporting processes much more efficient. P23R also signifies the introduction of a fundamental change in paradigms aimed at greater transparency and data economy in the fulfillment of information and reporting obligations between business and public administration.”

The P23R principle was developed in the context of the Federal Government's IT investment program by a consortium of 13 organizations from the business and science communities as well as from the Rhine Neckar Metropolitan Region. Companies such as BASF and DATEV pilot-tested P23R and have demonstrated that they can use it to fulfill their legal reporting obligations in a trustworthy environment both efficiently and without changes in medium.

Fraunhofer IESE designed and performed this project in collaboration with four other Fraunhofer institutes in Berlin, Stuttgart, and Sankt Augustin on behalf of the Federal Ministry of the Interior. IESE was responsible for the entire quality management of the project, for coordinating work regarding the technical and organizational constraints (which were necessary, among other things, to ensure the legal conformance of the reporting), and it was finally responsible for the acceptance and change management. In addition, IESE provided a prioritization methodology for the method guidelines that allows characterizing process chains between business and public administration regarding their usage potential and ranking them in accordance with the implementation priorities.

dbb Innovationspreis 2012

Öffentlicher Dienst: Ideen für alle

15. Oktober 2012





DENIT AT FRAUNHOFER IESE RECEIVES AWARD AS "SELECTED LANDMARK 2012"

Fraunhofer IESE is among the 16 winners from Rhineland-Palatinate in the contest "365 Landmarks in the Land of Ideas" 2012. At a reception at the State Chancellery of Rhineland-Palatinate in April 2012, Minister President Kurt Beck welcomed these 16 winners, whose ideas and projects are examples of the strong culture of innovation in the state and reflect important future trends. In order to promote the involvement and dedication of the people and to make exemplary ideas visible, the initiative "Germany – Land of Ideas" has been organizing the Germany-wide contest "365 Landmarks in the Land of Ideas" jointly with Deutsche Bank since 2006 already, rewarding excellent projects and ideas that make a lasting contribution to Germany's future viability.

Minister President Kurt Beck congratulated Thomas Luiz and Rolf H. van Lengen from the German Center for Emergency Medicine and Information Technology (DENIT) at Fraunhofer IESE on their award for a real-time central information system for hospital emergency capacities and presented them with the official plaque of the contest: "You, dear winners, have opened up new perspectives with your ideas. This award is the reward for your creativity and your courage to try something new", said the Minister President.

DENIT has developed an online application for Emergency Medical Services and hospitals in Rhineland-Palatinate that allows identification of treatment and care capacities without any loss of time. Available hospital capacities within easy reach can thus be checked as fast as possible. The central state-wide information system for hospital emergency capacities CISHEC (ZLB in German) also facilitates and accelerates the search

for emergency capacities beyond local hospitals. This enables faster reaction and allows saving lives.

During the course of the year, each of the 365 projects presented itself to the public as a "Selected Landmark" on one special day. Fraunhofer IESE presented itself on 9 November 2012 in the context of the "Science Night" in Kaiserslautern. In the presence of Roger Lewentz, State Minister in the Ministry of the Interior, for Sports and Infrastructure of the state of Rhineland-Palatinate, and Emanuel von Bodman, representative of the initiative "Germany – Land of Ideas", the award as "Selected Landmark Ort 2012" was presented by Andreas Rohde, Director, Rhineland-Palatinate Public Sector and Institutions at Deutsche Bank, who emphasized: "This joint online project is a flagship project for the region: Here, a life-saving idea was implemented creatively and intelligently – with a lot of dedication and passion for the common good." In his laudatory speech, he praised this as "exemplary dedication that symbolizes progress and shapes the future."

Prof. Dr. Dieter Rombach, director of Fraunhofer IESE, commented on the award: "We are very proud to be a "Selected Landmark in the Land of Ideas" for the third time. Once again, this has shown that we have managed to achieve the goal of DENIT, namely to optimize emergency care in Rhineland-Palatinate through innovative IT solutions, in a unique way."

The jury of experts consisting of scientists, business managers, journalists, and politicians selected DENIT at Fraunhofer IESE as an award winner from more than 2,000 applications.



FRAUNHOFER IESE AND INSIDERS TECHNOLOGIES FOUND JOINT RESEARCH & DEVELOPMENT LAB

Fraunhofer IESE, one of the leading institutes for software and systems engineering methods, and Insiders Technologies, the market leader in intelligent software products for document management from Kaiserslautern, are intensifying their strategic partnership with the foundation of a joint research and development lab in Kaiserslautern. In the Joint Research & Development Lab (JR&D Lab), which was presented to the interested public on 19 November 2012 in the context of a press conference, innovative products will be developed jointly using innovative development methods in order to expand the portfolio of products offered by Insiders on the basis of state-of-the-art research in line with current market trends.

Both partners expect to benefit a lot from this mutual transfer of knowledge and technology: Fraunhofer IESE will be able to empirically test the effectiveness and efficiency of its innovative development methods, for which the research institute is known worldwide, in more real projects. Prof. Dr. Dieter Rombach explained: "Through this strategic partnership with Insiders, we are realizing a sustainable future IT development model that can be transferred to small and medium-sized enterprises. What is unique in this project is the active involvement of reference customers even before the results are mature enough for industrial deployment." Werner Weiss, managing director of Insiders Technologies, was also enthusiastic about this novel type of cooperation with research: "At Insiders, we are looking forward to being able to use the highly acclaimed method competence of the Fraunhofer Institute and

to collaborate with a catalyst for innovation." Weiss counts on the Research & Development Lab to develop products that will fulfill the highest state-of-the-art scientific standards and will preserve the excellent position of his company in international competition in the area of document management.

In the ultramodern facilities of Fraunhofer IESE, employees of Insiders Technologies with many years of experience will collaborate in a team with Fraunhofer scientists. The first joint project will be work on the Mailroom Cockpit, a product for the company-wide, cross-system monitoring and controlling of all incoming document-related business processes, particularly for insurance companies.

Prof. Dr. Dieter Rombach and Werner Weiss are currently already planning activities to further promote the expansion of synergy effects between science and business: In addition to the development of further product innovations in the Joint Research & Development Lab, the collaboration shall also focus on such issues as mentoring of PhD candidates, joint professional publications, or research sabbaticals.

OUTLOOK ON 2013

EMBEDDED SOFTWARE IS BECOMING "SMART"

Contact

Dr. Mario Trapp
Phone +49 631 6800-2272
Fax +49 631 6800-9 2272
mario.trapp@iese.fraunhofer.de



Dr. Mario Trapp

For many years, the Division Embedded Systems has been focusing on the development of safety-critical and highly dependable embedded systems. In the meantime, the experts of Fraunhofer IESE have become the first point of contact for many companies when it comes to guaranteeing highest quality in their product innovations. Since wrong decisions during development can quickly cause huge financial damage to a company or might even endanger human lives, it is particularly important for these companies to have complete trust in the evaluations and solutions of Fraunhofer IESE. With the help of innovative modeling techniques, analyses, and simulations, the IESE experts therefore complement their own experience with objective, reproducible evidences to enable them to assist their customers at all times with quality assessments and recommended solutions that will stand up to scrutiny. The aim is to also fulfill this ambition on the road towards Smart Ecosystems, since Smart Ecosystems will only evolve from a promising idea to an economic success if one can demonstrably depend on their quality. In order to meet this challenge, Fraunhofer IESE has been working for several years already on developing innovative new solution approaches, which will also characterize its research work in the upcoming years.

On the way to Smart Ecosystems, embedded systems will increasingly interconnect with each other and will seamlessly integrate themselves into the "Cloud". To do so, the systems must open up in order to allow flexible connections with other systems and with the Internet. In addition, end customers increasingly expect that the flexibility they are used to from smartphone apps will also be supported by embedded systems. For embedded software to function efficiently in such a flexible environment, it must be able to adapt to its environmental context much more intensively as it does to date. It is this openness and adaptivity of the systems which holds the key for new applications and the resulting market potential. Reconciling this flexibility, which is well known from classical information systems, with the tough quality and cost requirements of embedded systems will certainly represent one of the greatest challenges in the next few years.

The openness and adaptivity of Smart Ecosystems lead to a significant increase in complexity and also make these systems hard to predict. Safety and reliability can therefore only be guaranteed efficiently if they are adequately taken into account as central properties during the entire development cycle. In this context, it is essential to always look at all system properties in their entirety, since particularly during the development of new system generations, companies encounter an investment risk and thus have a vested interest in making sure that this development will ensure the success of their product.

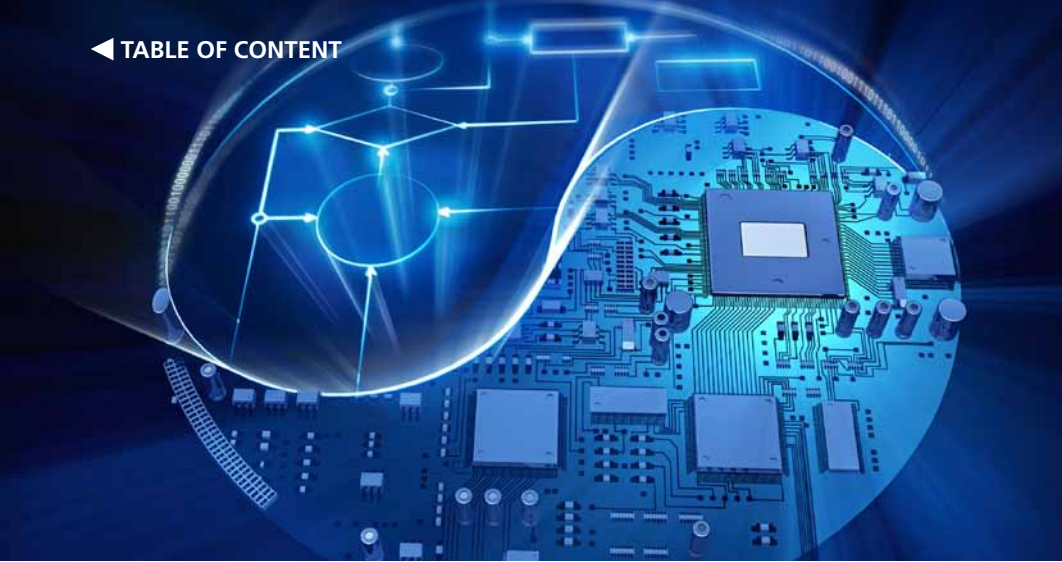

The groundwork for success or failure is already laid during the early phases of development: The flexibility of a system created by its openness and adaptivity is frequently the basis for new applications. At the same time, however, more flexibility also means higher costs and greater safety risks. It is thus important to understand very early which market one wants to address and which flexibility is really needed for that. In order to be able to assist its customers in these issues with recommendations that will hold up to close scrutiny, Fraunhofer IESE draws on more than 15 years of experience in the strategic planning and efficient implementation of system variants. Furthermore, the practice-proven methods of the institute are being continually evolved in order to deal even better with the new challenges posed by Smart Ecosystems.

Another success factor during the course of development is adequate architecture design. The system and software architecture does not only determine whether and how well the business goals can be achieved with the system. An appropriate architecture is also the indispensable basis for efficiently guaranteeing the safety and reliability of a system. Architecture decisions therefore have a great impact and must take into account all the target properties of a product – even if these are contradictory. The experts of Fraunhofer IESE use various model-based analysis and simulation methods including virtual hardware simulation to allow derivation of the best possible architecture for a specific product by exploring the design space on the basis of the analysis results.

In order to be able to support openness and adaptivity in Smart Ecosystems, embedded systems must be easy to adapt dynamically at runtime in the future, or must even be able to adapt themselves. Since the resulting system structures are hard to predict at development time, runtime platforms will become increasingly important in embedded systems, too, in the future. Fraunhofer IESE is therefore working intensively on a runtime platform aimed at guaranteeing openness and adaptivity in embedded systems safely and reliably. For this purpose, existing processes for modular safety cases are being extended to allow safe system and software integration at runtime by means of runtime certificates. These approaches are integrated into a runtime platform, which guarantees even in cases of dynamic software integration that there are no undesired interactions, and which will at the same time allow parallel execution of software components with different degrees of criticality on the same hardware.

TRENDS IN PROCESS MANAGEMENT

Contact

Dr. Jens Heidrich
 Phone +49 631 6800-2193
 Fax +49 631 6800-9 2193
jens.heidrich@iese.fraunhofer.de



Dr. Jens Heidrich

Efficient development processes and high-quality software systems and products are basic prerequisites for remaining competitive in a tightly fought global market. In the future, process management within individual organizations will thus be faced with great challenges due to the ever shorter business and technology lifecycles. Processes and quality assurance methods must therefore react flexibly and must be easy to adapt.

Software products and systems are increasingly being developed in a distributed manner in heterogeneous environments. This is particularly true for the trend towards Cyber-Physical Systems and Smart Ecosystems, where organizations from different domains collaborate on developing integrated solutions. In this context, the intensive interaction of embedded systems and information systems places high demands on process and quality management approaches in software engineering. The focus of the division "Process Management" of Fraunhofer IESE is on designing innovative development processes and corresponding approaches for the measurement and prediction of product and process properties aimed at meeting the challenges of tomorrow.

Strategic Software Measurement Systems for Organizational Control

It is becoming increasingly important for companies to understand software and IT as drivers for innovation and value creation and to be able to clearly demonstrate their contribution to the business goals of their organization. This is particularly crucial in the context of rapidly changing markets, which require an organization to focus on its most promising areas for its future development. Since 2005, Fraunhofer IESE has been working on the development of the GQM+Strategies® approach together with its U.S. sister institute CESE (Fraunhofer Center for Experimental Software Engineering). This approach supports companies in modeling goals and strategies across all levels of an organization as well as in developing appropriate software measurement systems for measuring the success and failure of goals and strategies. Due to their complexity, future systems will no longer be developed by a single organization on its own, but rather by a consortium of organizations. In order to keep up with these developments, the approaches must also be extended beyond the boundaries of a single organization in order to allow addressing goals and strategies holistically in a distributed, heterogeneous environment.

Assessment Centers for Software Quality

Software system quality is a very abstract term, which is often equated with reliability or defect-proneness. As a matter of fact, though, this term encompasses a whole series of properties of a software system (such as functionality, reliability, usability, efficiency, maintainability, or



portability). Quality models (such as ISO 9126 or its successor ISO 25000) describe which quality properties of a software system are important for an organization and how to measure these systematically during the development process and thus master them.

Since 2008, Fraunhofer IESE has been collaborating with renowned partners from industry and research on developing quality models for various application domains. Together with the customer, these models are adapted to the customer's individual demands and are applied to existing software systems in order to systematically assess their quality, identify weaknesses, and recommend appropriate improvement measures. To do so, Fraunhofer IESE has a comprehensive portfolio of state-of-the-art techniques, methods, and tools for the development and quality assurance of embedded systems and information systems at its disposal to ensure software quality in the long term. In the future, assessment centers will be established in this context in order to provide an infrastructure, incl. standardized quality models, for assessing software systems.

Multi-Disciplinary Process Frameworks

The process landscapes in modern organizations are built around a multitude of different development approaches: from classical, plan-based approaches such as the Rational Unified Process or the V-Modell XT, to agile methods such as Scrum and Extreme Programming. In addition, various requirements exist regarding compliance with standards, ranging from requirements on the general development standard, such as achievement of a specific CMMI or SPICE maturity level, to requirements from standards for specific system classes, such as IEC 61508 (Functional Safety) and the respective domain-specific derivatives.

Since 2010, Fraunhofer IESE has been working on the issue of multi-model compliance in this context. The goal is to sustainably reduce the effort required for proving compliance to several development standards. Future developments will aim at providing this evidence in a multi-disciplinary environment in which various development approaches of different organizations will have to be combined to allow creation of an integrated system as efficiently as possible.

INFORMATION SYSTEMS OF THE FUTURE

Contact

Dr. Jörg Dörr
 Phone +49 631 6800-1601
 Fax +49 631 6800-9 1601
 joerg.doerr@iese.fraunhofer.de



Dr. Jörg Dörr

Future information systems will have to fulfill high demands on quality. The systematic use of software engineering methods can guarantee the required quality in a system. In 2013, our focus will continue to be particularly on the qualities mobility and security. Similar to last year, another important core topic of the division "Information systems" will be how to increase software development efficiency. And finally we are increasingly striving to make software engineering methods tangible and experienceable.

Mobility of Complex Information Systems

In 2013, Fraunhofer IESE will continue to further expand its portfolio of software engineering methods for the context of mobile end devices. Following the successful definition and industrial application of the mConCappt method for defining the interaction design of mobile devices and of the methodology for the evaluation of the mobility potential of business processes, the focus in 2013 will now also be on quality assurance methods: Parallel business processes, enabled also and in particular by mobile devices, entail the issue of call nesting, respectively the issue of using jointly used data. With the help of the approach developed by Fraunhofer IESE, competing data accesses are identified and tested.

Empiricism-based Industry Lab for Mobile Business Applications

During the course of the year, the "Empiricism-based Industry Lab for Mobile Business Applications with Guaranteed Quality" will start its operation. In this lab, industry customers will be able to test and apply the IESE methods and tools on their own products or product ideas together with IESE staff. For this purpose, the lab will provide a unique software and hardware infrastructure, which will allow developing mobile business applications for current mobile platforms (iOS, Android, Windows) with state-of-the-art and state-of-the-practice tools on the one hand, and perform quality assurance for such applications on the other hand. For the development and, in particular, for quality assurance, numerous mobile devices (smartphones, tablets) by popular manufacturers as well as a customized test infrastructure for mobile business applications will be available.

Security in Smart Ecosystems

Fraunhofer IESE's presentation at this year's CeBIT will focus on the topic of Software Engineering for Smart Ecosystems, illustrated on the example of Smart Farming. The division Information Systems will demonstrate how its technology for distributed data usage control can be used in Smart Farming for safely exchanging sensitive data between systems and organizations. Thanks



to the policies used in this method, the data owners continue to maintain control over their data in the sense that these data can only be used for the specified usage. In 2013, the competencies from the area of data usage control will thus also be increasingly transferred from the area of pure information systems to the area of embedded systems. Another focus in the area of data usage control will be on the issue of Context Awareness, i.e., the goal is to also enable policies that allow controlled data usage in specified, automatically captured contexts.

Increasing Software Development Efficiency

Many companies want to further improve the quality of their product on the one hand, and increase the efficiency of their development on the other hand. Fraunhofer IESE is continuing its research into how to increase the efficiency of software engineering methods: In the area of architecture, Fraunhofer IESE will in 2013 publish the results of its large international study on the state of the practice in documenting software architecture. In this study, more than 100 participants from numerous countries and various domains report on their experiences with architecture documentation and identify needs for improvement. This complements experiences from many IESE projects and will be the basis for the optimization of methods and tools in order to generate maximum benefit for industry. In addition, the efficient introduction of business process management (BPM) is becoming increasingly interesting for companies. However, this comes with major challenges, as it entails long-term changes in the areas of work philosophy, procedures, role models, and software applications. In order to be able to introduce BPM efficiently and successfully, in 2013 Fraunhofer IESE will thus offer a proven approach for the holistic, yet incremental introduction of BPM.

Experiencing Software Engineering Methods

Presenting software engineering methods in a tangible way is an important factor for successful technology transfer. For this purpose, Fraunhofer IESE has also focused on the description of the methodology via apps in the App-Store since 2012. Methods are made experienceable with examples and videos, and are explained step by step. In 2013, Fraunhofer IESE will put more descriptions online, for example how to design intuitive user interfaces (IBIS methodology), how to assess software architectures (ACES methodology), and its proven RE process improvement with Reqman.

TRENDING: RESEARCH AREA "SMART ECOSYSTEMS"

Contact

Dr. Jens Knodel
Phone +49 631 6800-2168
Fax +49 631 6800-9 2168
jens.knodel@iese.fraunhofer.de



Dr. Jens Knodel



Interconnectedness – the cross-domain megatrend for software and systems – will be the challenge in future software engineering. USPs will increasingly be generated by interconnecting one's own software with other systems. To achieve this, a change of paradigms is going to take place: from monolithic single systems to open, interconnected, scalable, and service-oriented Software Ecosystems. So far, three different system classes can be characterized today:

- Information systems generally describe the technical and organizational processes used for obtaining and processing information. Information systems are usually systems for supporting and/or automating business processes.
- Embedded systems are systems for the product-integrated control, monitoring, and/or regulation of a technical process via sensors and actuators. The system is here integrated directly into the technical context.
- Mobile systems consist of at least one application that is used on one or several mobile end devices. We talk about mobile business systems (or business applications) when these systems support business processes.

These system classes are continually evolving. In the area of Information Systems, Emergent Enterprise Software Systems are the next phase of the evolution towards the Internet of Services. Interconnected Embedded Systems, on the other hand, are becoming Cyber-Physical Systems (CPS) and will finally lead to the Internet of Things. In both system classes, Mobile Systems are also being increasingly integrated into business processes today.

- Emergent Enterprise Software Systems are integrated Information Systems that are created through the combination and modification of components from different manufacturers according to the principle of emergence (i.e., that do not necessarily need to be planned in advance).
- Cyber-Physical Systems (CPS) describe the tight integration of Embedded Systems via dedicated communication infrastructures such as the Internet. With the help of sensors, the physical world is represented through digital objects.

So-called Smart Ecosystems represent the mid-term evolutionary phase. They form a bridge between the Information Systems domain and the Embedded Systems domain. Smart Ecosystems connect Emergent Systems and CPS into a single ecosystem in which the Internet of Services, Things, and Data merge with each other, thus resulting in cross-organizational innovative solutions. Business processes and technical processes are equally valuable and impact each other mutually in order to achieve optimization from global perspectives. As an extension of the classical Software Ecosystem, the Smart Ecosystem also integrates non-trivial Information Systems

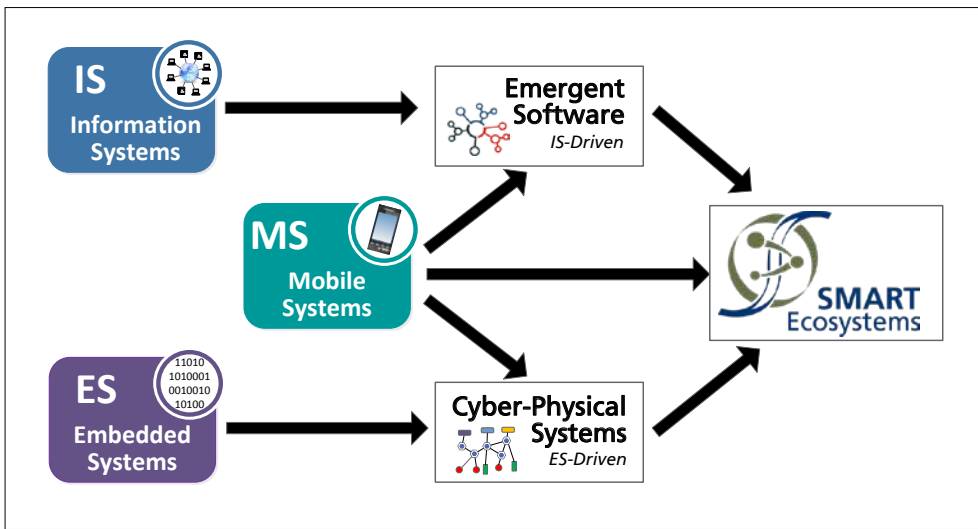

*Smart Ecosystems:
Evolution of the system classes
of Information Systems and Em-
bedded Systems towards Smart
Ecosystems*

in order to achieve organizational goals and non-trivial Embedded Systems to achieve technical goals. In doing so, they act as one unit, which dynamically uses context-dependent information to achieve common higher-level goals (which no single system would be able to achieve on its own). In the research area “Smart Ecosystems”, we are preparing for the future of Software Engineering. We are working particularly, although not exclusively, on the following issues:

- Lifecycle management in Smart Ecosystems: Given the multitude of single systems, how can different processes, methods, and tools be reconciled?
- Modeling of requirements and workflows in ecosystems: Given uncertain contexts and ad-hoc connections, how can requirements be elicited and documented for single systems?
- Architectures for Software Ecosystems: What do building plans, structures, and system behavior look like? How to achieve control over the inherent complexity of the interconnect-edness? How to design the governance of ecosystems?
- Runtime technologies: What do runtime platforms look like that enable high quality (e.g., security and safety) in Smart Ecosystems?
- Participative software development: How to design open and collaborative cooperation with equal rights across organizational boundaries?
- User Experience plays an important role in how innovations are perceived and used. How can software enable its users to work effectively and efficiently in an ecosystem?

THE FRAUNHOFER-GESELLSCHAFT

Fraunhofer worldwide

Locations in Europe

Paris, France
Brussels, Belgium
Vienna and Graz, Austria
Bozen, Italy
Porto, Portugal
Glasgow, Scotland
Gothenburg, Sweden
Wroclaw, Poland
Thessaloniki, Greece

Locations in North and South America

London, Ontario, Canada
Brookline, Massachusetts
Cambridge, Massachusetts
College Park, Maryland
East Lansing, Michigan
Newark, Delaware
Plymouth, Michigan
San Jose, California
Salvador, Brazil
Campinas, Brazil
São Paulo, Brazil
Santiago, Chile

Locations in Asia and Australia

Bangalore, India
Beijing, China
Jakarta, Indonesia
Selangor D.E., Malaysia
Seoul, Korea
Singapore
Tokyo und Sendai, Japan
Sydney, Australia

Locations in the Middle East

Dubai, United Arab Emirates
Cairo, Egypt

Research of practical utility lies at the heart of all activities pursued by the Fraunhofer-Gesellschaft. Founded in 1949, the research organization undertakes applied research that drives economic development and serves the wider benefit of society. Its services are solicited by customers and contractual partners in industry, the service sector and public administration.

At present, the Fraunhofer-Gesellschaft maintains 66 institutes and independent research units. The majority of the more than 22,000 staff are qualified scientists and engineers, who work with an annual research budget of 1.9 billion euros. Of this sum, more than 1.6 billion euros is generated through contract research. More than 70 percent of the Fraunhofer-Gesellschaft's contract research revenue is derived from contracts with industry and from publicly financed research projects. Almost 30 percent is contributed by the German federal and Länder governments in the form of base funding, enabling the institutes to work ahead on solutions to problems that will not become acutely relevant to industry and society until five or ten years from now.

Affiliated international research centers and representative offices provide contact with the regions of greatest importance to present and future scientific progress and economic development.

With its clearly defined mission of application-oriented research and its focus on key technologies of relevance to the future, the Fraunhofer-Gesellschaft plays a prominent role in the German and European innovation process. Applied research has a knock-on effect that extends beyond the direct benefits perceived by the customer: Through their research and development work, the Fraunhofer Institutes help to reinforce the competitive strength of the economy in their local region, and throughout Germany and Europe. They do so by promoting innovation, strengthening the technological base, improving the acceptance of new technologies, and helping to train the urgently needed future generation of scientists and engineers.

As an employer, the Fraunhofer-Gesellschaft offers its staff the opportunity to develop the professional and personal skills that will allow them to take up positions of responsibility within their institute, at universities, in industry and in society. Students who choose to work on projects at the Fraunhofer Institutes have excellent prospects of starting and developing a career in industry by virtue of the practical training and experience they have acquired.



Prof. Dr. Reimund Neugebauer
President, Corporate Management



Prof. Dr. Ulrich Buller
Research Planning



Prof. (Univ. Stellenbosch)
Dr. Alfred Gossner
Finance and Controlling, IT



Dr. Alexander Kurz
Legal Affairs, Personnel Affairs

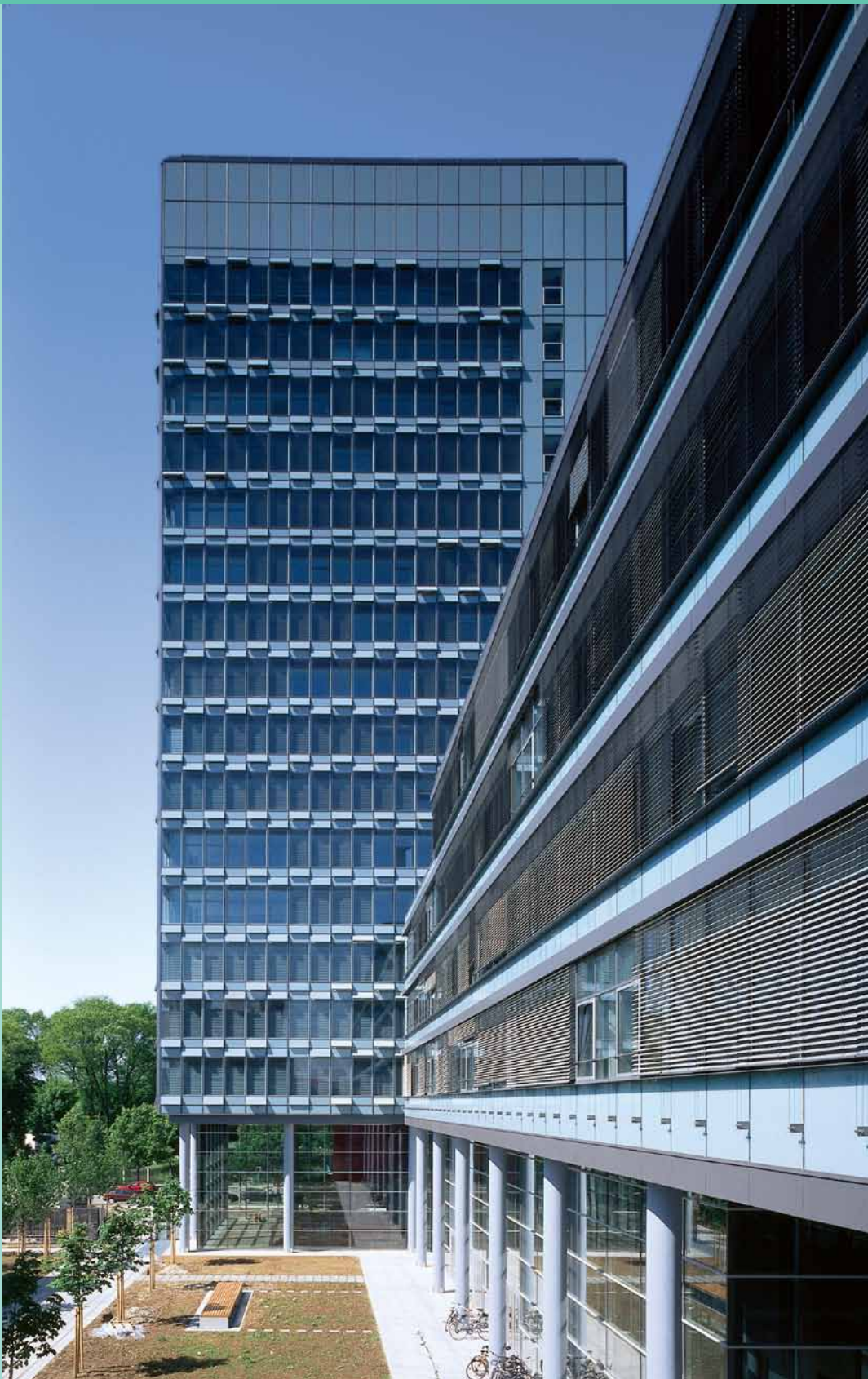

Address

Fraunhofer-Gesellschaft e. V.
Hansastraße 27c
80686 München, Germany
info@zv.fraunhofer.de
www.fraunhofer.de



The man behind the name:

Joseph von Fraunhofer

The Fraunhofer-Gesellschaft owes its name to Joseph von Fraunhofer (1787-1826), the successful Munich researcher, inventor and entrepreneur. Born of a family of modest means, the glass-grinding apprentice Joseph von Fraunhofer joined the institute for optics headed by privy councillor Joseph von Utzschneider, who put the young researcher in charge of glass manufacturing at the early age of 22. Joseph von Fraunhofer's major developments include new methods of glass production and processing.

The optical instruments he himself developed, such as the spectrometer and the diffraction grid, enabled Fraunhofer to conduct fundamental research in the fields of light and optics. He was the first scientist to measure the spectrum of sunlight and characterize the appearance of the dark absorption strips: the "Fraunhofer lines". His work as an autodidactic researcher earned him great respect in academia and government, leading to the former apprentice becoming a full-fledged member of the Bavarian Academy of Sciences and Humanities.

FRAUNHOFER IESE AND ITS NETWORK PARTNERS

Fraunhofer IESE fulfills its mission of applied research and technology transfer through close collaboration with users of software engineering technology, providers of new technologies, and strategic partners in national and international collaborations. Thus, IESE actively promotes further development of software engineering technology and its transfer into industrial practice.

International Research Networks

Fraunhofer IESE is a member in several international research associations. The International Software Engineering Research Network (ISERN) with approx. 60 members from science and industry plays an important role in Fraunhofer IESE's international research collaborations. ISERN is a forum for applied software engineering researchers for exchanging the latest research results and experiences.

Further information:

<http://isern.iese.de>



In addition, Fraunhofer IESE is affiliated with the Center for Empirically Based Software Engineering (CeBASE), a project of the National Science Foundation (NSF) in the United States. Other CeBASE members include FC-MD, the University of Maryland, the University of Southern California, Mississippi State University, and the University of Nebraska-Lincoln.

Bilateral research and exchange programs for students and scientists exist with renowned institutions such as:

- Experimental Software Engineering Group at the University of Maryland, USA
- Center for Software Engineering at the University of Southern California, USA
- Universidade Federal da Bahia, Brazil
- Universidade Estadual da Paraíba, Campina Grande, Brazil
- Carleton University, Toronto, Canada
- Clemson University, South Carolina, USA
- Kyungpook National University, South Korea,
- Simula Research Laboratory, Lysaker, Norway
- National ICT Australia Ltd (NICTA), Sydney, Australia
- Bay Zoltan Foundation for Applied Research, Budapest, Hungary
- Poznan University of Technology, Poland



National Research Networks

The **Science Alliance Kaiserslautern e.V.** is a coalition of twelve internationally renowned research facilities in Kaiserslautern. Together they form a highly specialized multidisciplinary network, which provides students, scientists, and cooperation partners from industry, business, and the public sector with innovative solutions based on the newest technologies and methods available.

Members of the Science Alliance are the University of Kaiserslautern, the University of Applied Sciences Kaiserslautern, and eight research institutes, some of which are spin-offs of successful research completed at the University of Kaiserslautern. The Commercial Vehicle Cluster GmbH and the Westpfalz-Klinikum are also part of the alliance. Their prolific work in the past years has added to the growing reputation of Kaiserslautern as a distinguished location for study, research, and technology.

Further information:
www.science-alliance.de



SafeTRANS e.V. (“Safety in Transportation Systems”) is a Competence Cluster combining research and development expertise in the area of complex embedded systems in transportation systems. SafeTRANS drives research in human-centered design, in system and software development methods for embedded systems, as well as in safety analysis and – for avionics and rail – its integration in certification processes, driven by a harmonized strategy addressing the needs of the transportation sector.

Further information:
www.safetrans-de.org



The cluster “**Software Innovations for the Digital Enterprise**” (or **Software-Cluster** for short) focuses on the region around the software development centers Kaiserslautern, Darmstadt, Karlsruhe, Saarbrücken, and Walldorf. Its objective is to explore and develop the enterprise software of the future. This will enable companies that have only been using ICT as a tool to support their traditional processes to transform themselves into completely digital enterprises where ICT is the major driver for product and process innovations (also see page 100 for further details).

Further information:
www.software-cluster.org



The Transfer Agency for the Software-Cluster Rhineland-Palatinate (TSC-RLP) is responsible for facilitating technology transfer and communication between the Software-Cluster and small and medium-sized enterprises in Rhineland-Palatinate and for bringing their wishes and research needs to the Cluster. In addition, the Transfer Agency is dedicated to establishing regional networks.







Industrially-funded Collaborations

Fraunhofer IESE's industrial cooperation partners range from global players to small regional companies. They can be grouped into four categories:

- Large national and international organizations looking for support in their mid- to long-term strive for quality improvement in software development.
- Large national and international organizations with their own R&D department, who are looking for competent research partners.
- Medium-sized enterprises, who want to establish improvement programs or who must implement technology changes under very tight budget and schedule constraints.
- Small companies, who want to use proven technology that yields short-term return on investment.

Specialized Services for SMEs

The speed of modern innovations and the rapid changes of economic constraints place high demands on the management of IT companies. A company that wants to survive in the fierce competition is therefore well advised to continually improve both its own development processes and products and the qualification of its employees.

This is where the Software Technologie Initiative e. V. comes in. It offers all participants the opportunity to receive constant and first-hand information about current developments, trends, and background in the area of software engineering. Numerous events serve to acquire and consolidate applicable knowledge, while also offering the chance for people to get to know each other and to communicate with others. As a living network between research and practice, STI e. V. is the regional platform for direct, unfiltered exchange of knowledge, experience, and information in the area of software development.

Objectives:

- Promotion of software technology in small and medium-sized companies in the region
- Bundling of interests regarding the adaptation of research results in the area of software engineering
- Promotion of innovative software development approaches and their transfer into practice

Contact

Thomas Jeswein
Phone +49 631 6800-2106
Fax +49 631 6800-9 2106
thomas.jeswein@iese.fraunhofer.de



Thomas Jeswein

www.sti-ev.de

IESE IN FRAUNHOFER GROUPS AND ALLIANCES

FRAUNHOFER INFORMATION AND COMMUNICATION TECHNOLOGY GROUP

Shorter innovation cycles have turned IT knowledge into a perishable commodity. The Fraunhofer Information and Communication Technology Group (ICT) provides support in the form of customized solutions, consulting, and contract research for new products and services. The Fraunhofer ICT Group comprises 18 institutes as full members (among them also Fraunhofer IESE), including three associated members, representing a workforce of roughly 4000 employees and a yearly budget of approximately 200 million euros. Its central office in Berlin serves as a one-stop shop, referring customers to the appropriate contacts.

The complementary focal fields of the participating institutes cover the entire value chain of the ICT industry. The business areas are:

- Digital Media
- E-Business
- E-Government
- Information and Communication Technologies
- Energy and Sustainability
- Medicine
- Production
- Security
- Financial Services
- Automotive

Chairman of the ICT Group

Prof. Dr. Matthias Jarke
Fraunhofer Institute for Applied
Information Technology FIT

The alliance comprises the Fraunhofer Institutes for

- Algorithms and Scientific Computing SCAI
- Applied Information Technology FIT
- Applied and Integrated Security AISEC
- Industrial Engineering IAO
- Medical Image Computing MEVIS
- Digital Media Technology IDMT
- Experimental Software Engineering IESE
- Computer Graphics Research IGD
- Integrated Circuits IIS (associated member)
- Intelligent Analysis and Information Systems IAIS
- Communication, Information Processing and Ergonomics FKIE
- Heinrich Hertz Institute, HHI (associated member)
- Open Communication Systems FOKUS
- Optronics, System Technologies and Image Exploitation IOSB
- Secure Information Technology SIT
- Software and Systems Engineering ISST
- Communication Systems ESK (associated member)
- Industrial Mathematics ITWM

Contact at IESE

Prof. Dr. Dieter Rombach
dieter.rombach@iese.fraunhofer.de

www.iuk.fraunhofer.de



Prof. Dieter Rombach



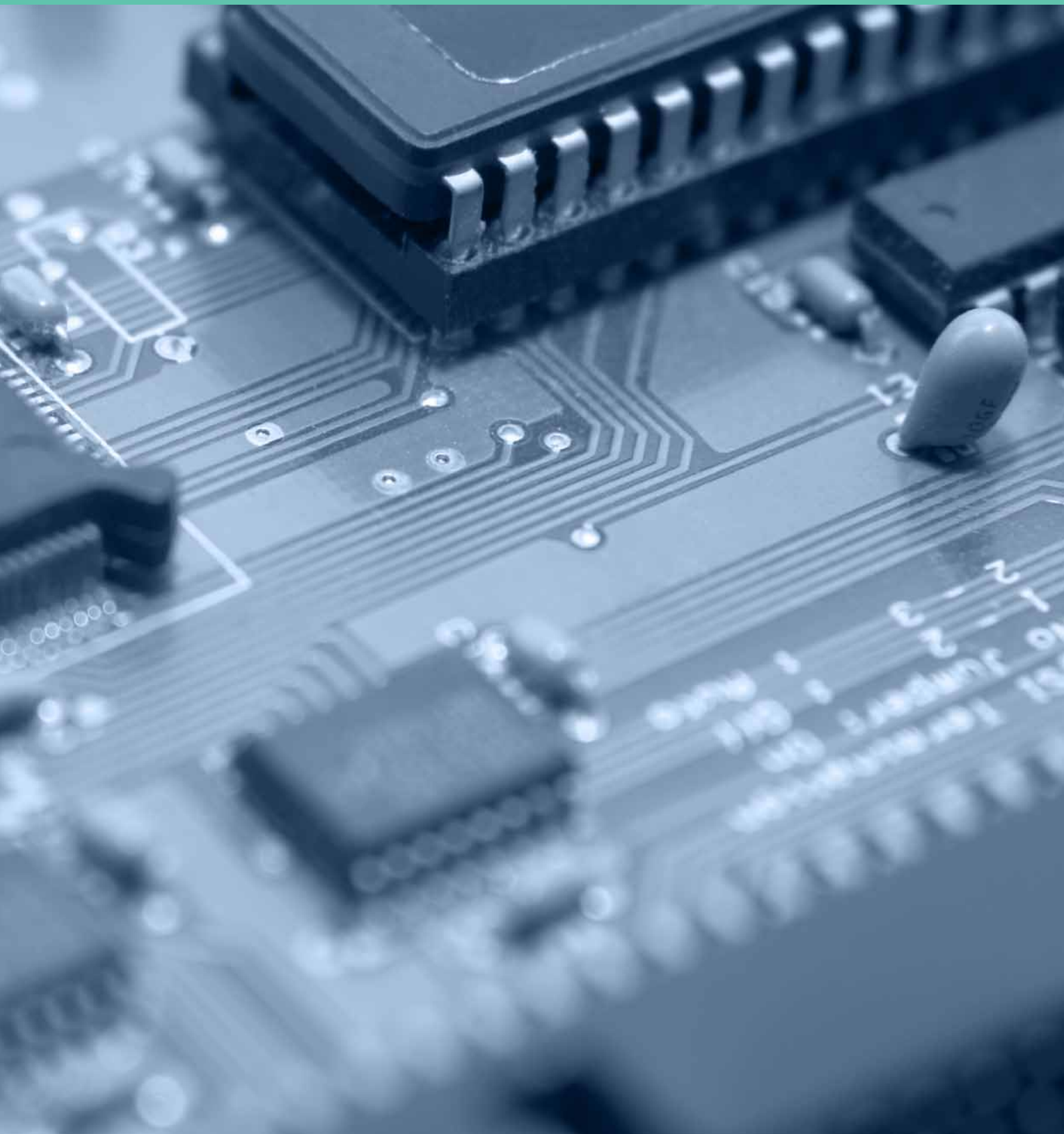



FRAUNHOFER ALLIANCE EMBEDDED SYSTEMS

Embedded systems constitute a central ingredient of technical products, e.g., in transportation, medical technology, automation technology, or in consumer electronics. In recent years, numerous product innovations and unique selling points of technical products "made in Germany" were the result of integrating embedded systems. Especially in the area of high-tech, there is a strong dependency on embedded systems, which is why their economic significance is enormous. As a reaction to the growing requirements and the increasing complexity of embedded systems, the Fraunhofer ICT Group as the largest European research network for information and communication technology pushed the initiative for founding a Fraunhofer Alliance.

Isolated approaches quickly reach their limits when new systems are being developed. In addition to competence in the areas of information technology, electrical engineering, and mechanical engineering, interaction between these disciplines is an essential factor. The Fraunhofer institutes affiliated in the alliance have the necessary comprehensive expertise in practically all topics in the area of embedded systems. The Fraunhofer Alliance Embedded Systems bundles the respective required professional competencies and maps them to the areas of information technology, electrical engineering, and mechanical engineering. At the same time, the alliance acts as a central point of contact for partners from industry, research, government, and the media.

Due to its expertise in the area of embedded systems, Fraunhofer IESE in Kaiserslautern is predestined for a leading role in the alliance. For a long time, safety analyses, embedded systems certification, especially in critical application domains, as well as innovative development methods for embedded systems have been focal research areas of IESE.

The alliance comprises the Fraunhofer Institutes for

- Applied and Integrated Security AISEC
- Communication Systems ESK
- Applied Information Technology FIT
- Communication, Information Processing and Ergonomics FKIE
- Open Communication Systems FOKUS
- Heinrich Hertz Institute, HHI
- Experimental Software Engineering IESE
- Factory Operation and Automation IFF
- Computer Graphics Research IGD
- Integrated Circuits IIS
- Optronics, System Technologies and Image Exploitation IOSB
- Production Technology IPT (Project Group Mechatronic Systems Design)

Spokesman of the Alliance and Contact at IESE

Prof. Dr.-Ing. Peter Liggesmeyer
Phone +49 631 6800-2106
Fax +49 631 6800-9 2106
peter.liggesmeyer@iese.fraunhofer.de

www.embedded.fraunhofer.de



Prof. Peter Liggesmeyer



FRAUNHOFER E-GOVERNMENT CENTER

The Fraunhofer E-Government Center combines the expertise of seven Fraunhofer Institutes in the areas of research needed to build up broad-based eGovernment services in Germany and Europe. Each institute has extensive experience in its particular area of technology and related applications, is already working on several applied eGovernment projects, and is actively involved in the definition of future-oriented, long-term solutions.

The Fraunhofer E-Government Center gives advice to politicians, public administrators, and business people on the conception and development of complete, forward-looking and secure eGovernment solutions and on the realization of service-oriented architectures and standards.

The services it offers also include reorganizing business processes, evaluating and advising on technology, developing future-oriented eGovernment lab scenarios and evolving long-term eGovernment and security solutions, carrying out projects and quality management, helping with standardization, transferring know-how, and training. The Fraunhofer E-Government Center is completely independent of any vendor-specific solutions and political movements.

Each institute in the E-Government Center has many years of experience in the area of technologies and applications and is involved in various eGovernment development projects. As the regional representative of the E-Government Center in Rhineland-Palatinate, Fraunhofer IESE supports both the public sector and software developing organizations in developing and extending benefit-oriented eGovernment solutions for business, public administration, and citizens. In particular, Fraunhofer IESE offers the following services: execution of needs and ROI analyses, independent quality assurance and support of realization projects (with special attention paid to system architecture, usability, and IT security issues), as well as support in developing eGovernment know-how. In order to ensure optimal coverage of the technological and application-relevant issues, projects are performed in cooperation with other institutes of the Fraunhofer E-Government Center when appropriate.

The Center comprises the Fraunhofer Institutes for

- Applied Information Technology FIT
- Experimental Software Engineering IESE
- Industrial Engineering IAO
- Optronics, System Technologies and Image Exploitation IOSB
- Intelligent Analysing- and Information Systems IAIS
- Open Communication Systems FOKUS
- Secure Information Technology SIT

Spokesman of the Alliance

Dr. Michael Tschichholz
Fraunhofer Institute for Open
Communication Systems FOKUS

Contact

Thomas Jeswein
Telefon +49 631 6800-2106
Fax +49 631 6800-9 2106
thomas.jeswein@iese.fraunhofer.de



Thomas Jeswein

www.egov-zentrum.fraunhofer.de



FRAUNHOFER AMBIENT ASSISTED LIVING ALLIANCE

The institutes of the Fraunhofer Alliance Ambient Assisted Living work together on developing holistic AAL and “personal health” system solutions for comfort, safety, and energy efficiency, for working and living, for health and social networking. The aim is to enable especially elderly or disabled persons or those requiring care to lead long, autonomous lives in their own homes.

The AAL environments being created for this purpose adapt to users’ needs and goals unaided, in a proactive and situation-specific way. “Personal health” components for health-related applications in home or mobile environments allow person-centered, individualized forms of medical care.

The goal is a common system concept that integrates different technologies and applications into modular systems consisting of interoperable components. Accordingly, the AAL Alliance covers the entire value chain from the private user to the professional service provider. Accompanying activities of the AAL Alliance are going on in the areas of research coordination, business model development, and standardization.

The contribution of Fraunhofer IESE is mostly in the area of systematic development of software-intensive systems. For the context of AAL, this includes approaches to the systematic development of integrated AAL solutions with predictable quality, development approaches for adaptable and adaptive systems, system modeling, and analysis, e.g., regarding dependability and usability.

The alliance comprises the Fraunhofer Institutes for

- Applied Information Technology FIT
- Open Communication Systems FOKUS
- Computer Graphics Research IGD
- Digital Media Technology IDMT
- Experimental Software Engineering IESE
- Industrial Engineering IAO
- Integrated Circuits IIS
- Manufacturing Engineering and Automation IPA
- Microelectronic Circuits and Systems IMS
- Photonic Microsystems IPMS
- Reliability and Microintegration IZM
- Software and Systems Engineering ISST
- Telecommunications, Heinrich Hertz Institute HHI

Spokesman of the Alliance

Dr. Reiner Wichert
Fraunhofer Institute for Computer
Graphics Research IGD

Contact

Rolf Hendrik van Lengen
Phone +49 631 6800-2103
Fax +49 631 6800-9 2103
rolf.van.lengen@iese.fraunhofer.de

www.aal.fraunhofer.de



*Rolf Hendrik van
Lengen*

ORGANIZATIONAL STRUCTURE

Organizational Structure of the Fraunhofer Institute for Experimental Software Engineering IESE

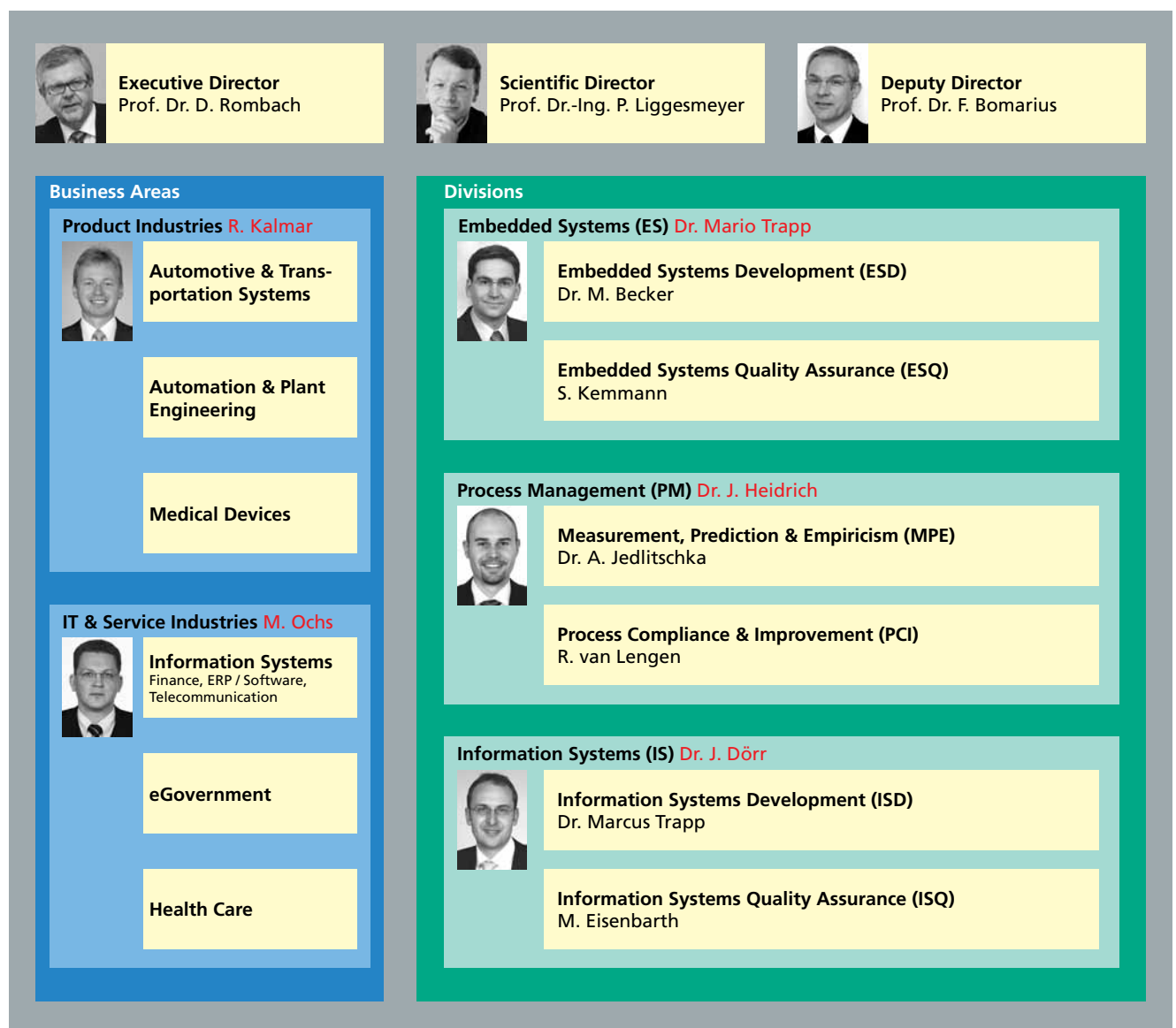



The Fraunhofer Institute for Experimental Software Engineering IESE

The Fraunhofer Institute for Experimental Software Engineering (IESE) develops innovative constructive and analytical processes for the development of dependable software to be used for controlling technical products and processes as well as business processes. These processes are successfully introduced in companies from all branches of industry to increase quality and decrease costs, thus adding business value. Currently, many diverse collaborations exist with companies from the product industries "Automotive and Transportation Systems", "Automation and Plant Engineering", and "Medical Devices" as well as from the IT and service industries "Financial Service Providers", "ERP and Software Producers", and "Telecommunication" (Information Systems), "eGovernment", and "Health Care". Fraunhofer IESE supports companies from all branches of industry in their efforts to achieve "innovation with dependable software"!

Business Areas and Departments

The business areas of Fraunhofer IESE are found in industries with a focus on software in products and on software in IT and service industries. Regarding software in products, the following business areas are addressed:

- Automotive and Transportation Systems
- Automation and Plant Engineering
- Medical Devices

Regarding software in IT and service industries, the following business areas are covered:

- Information Systems, especially Financial Service Providers, ERP and Software Producers, Telecommunication
- eGovernment
- Health Care

Each of these two sectors is led by a Business Area Manager, who is responsible for acquiring new customers.

Fraunhofer IESE has organized its competencies into three divisions. Two divisions are home to the competencies for developing embedded systems with a focus on functional safety, reliability, and availability, and for developing information systems with a focus on usability and security.

- Embedded Systems division with the departments for Development and Quality Assurance
- Information Systems division with the departments for Development and Quality Assurance

In addition, the third division deals with the interdisciplinary competencies of measurement and process improvement:

- Process Management division with the departments for Measurement, Prediction, and Empiricism and for Process Compliance and Improvement

These interdisciplinary competencies are necessary in order to firmly entrench processes for the development of embedded systems and information systems in an organization.

New competence areas are built up in so-called Living Labs, where research takes place concomitant with business model development. Examples of these areas are Ambient Assisted Living or Energy Management.

Fraunhofer IESE receives guidance and counsel from an advisory board consisting of international experts from science and business. For many years, Fraunhofer IESE has been successful on the market. The level of acquisition of third-party funds is on a consistently high level, between 70 and 80%.



Meeting of the Advisory Board on 8 November 2012

THE ADVISORY BOARD

The Advisory Board consists of representatives of research, industry, and government. The board members support the Institute Directors with advice and counsel. (Chairman: Prof. Dr. Ernst Denert, Vice-Chairman: Prof. Dr. Jürgen Nehmer)

Research

Prof. Dr. Victor Basili

Institute for Advanced Computer Science
Department of Computer Science
University of Maryland
USA

Prof. Dr. Manfred Broy

Institute for Computer Science
Technische Universität München

Prof. Dr. Helmut Krcmar

Chair for Information Systems
Computer Science Department
Technische Universität München

Prof. Dr. Jürgen Nehmer

Vice-Chairman of the Advisory Board
Department of Computer Science
University of Kaiserslautern

Prof. Dr. Helmut Schmidt

President
University of Kaiserslautern

Prof. Dr. Mary Shaw

Department of Computer Science
Carnegie Mellon University
Pittsburgh, PA
USA

Industry

Dr. Reinhold E. Achatz

Head of Corporate Technology, Innovation & Quality
ThyssenKrupp AG
Essen

Dr. Klaus Grimm

Director Software Technology
Daimler AG
Sindelfingen

Harald Hönninger

Head of Development
Research and Advance Engineering
Robert-Bosch GmbH
Schwieberdingen

Dr. Martin Verlage

Vice Executive Director
vwd group Technology
Frankfurt

Government

Dr. Erasmus Landvogt

Regierungsdirektor, IT Systems
Federal Ministry of Education and Research (BMBF)
Bonn

Stefanie Nael

Regierungsrätin
Ministry of Economic Affairs, Climate Protection, Energy and Regional Planning, Land Rheinland-Pfalz

Dr. Achim Weber

Director, "International and European Research, Knowledge and Technology Transfer"
Ministry of Education, Science, Youth and Culture, Land Rheinland-Pfalz
Mainz

Private Members

Prof. Dr. Ernst Denert

Chairman of the Advisory Board
Former Chairman of the Board
IVU Traffic Technologies AG
Grünwald

Dr. Hans-Ulrich Wiese

Former member of the Executive Board of Fraunhofer-Gesellschaft e. V.
Gräfelfing

PERSONNEL AND BUDGET

Development of Budget (in T euro).

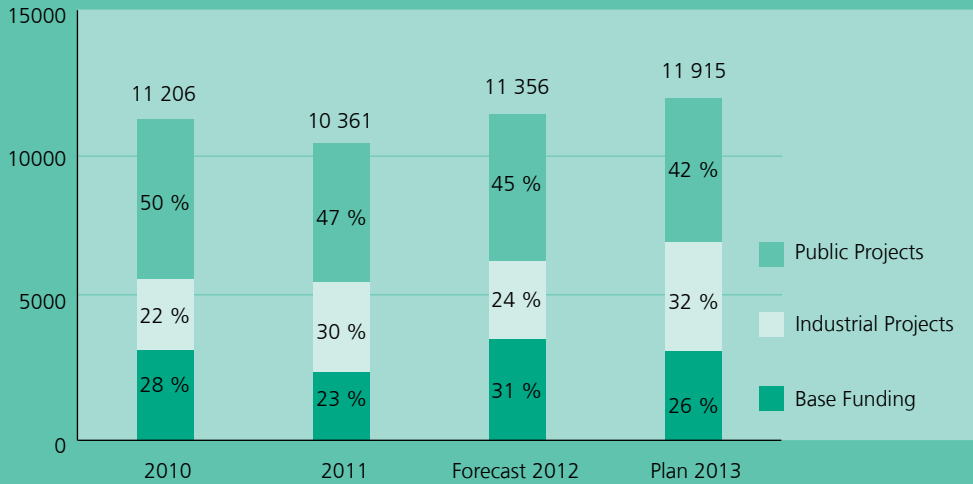

Development of Costs (in T euro).

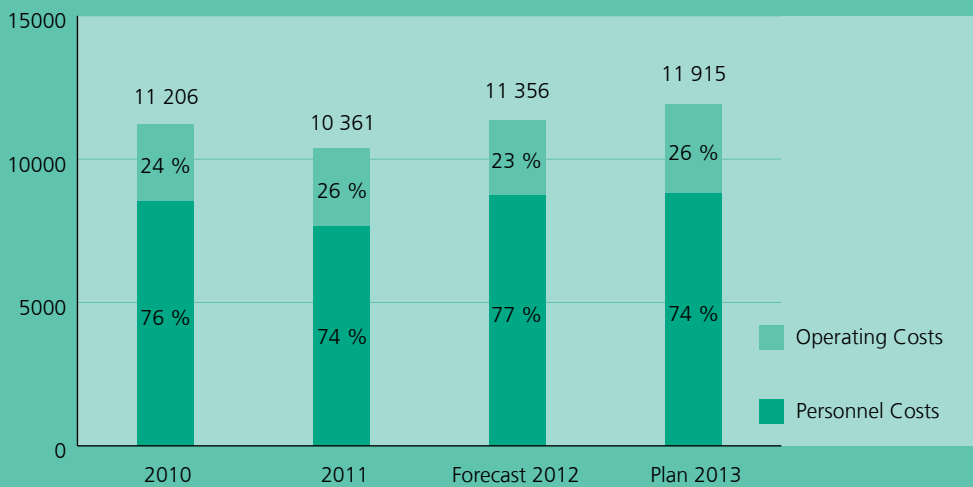

Development of Personnel and Budget

Following a strategic realignment in 2011, the year 2012 was characterized by various consolidation measures and increased focusing on the institute's core competencies. For 2013, the institute plans to grow in accordance with the number and size of its projects.

The proportion of female employees has remained stable at 27%.

Development of IESE Personnel.

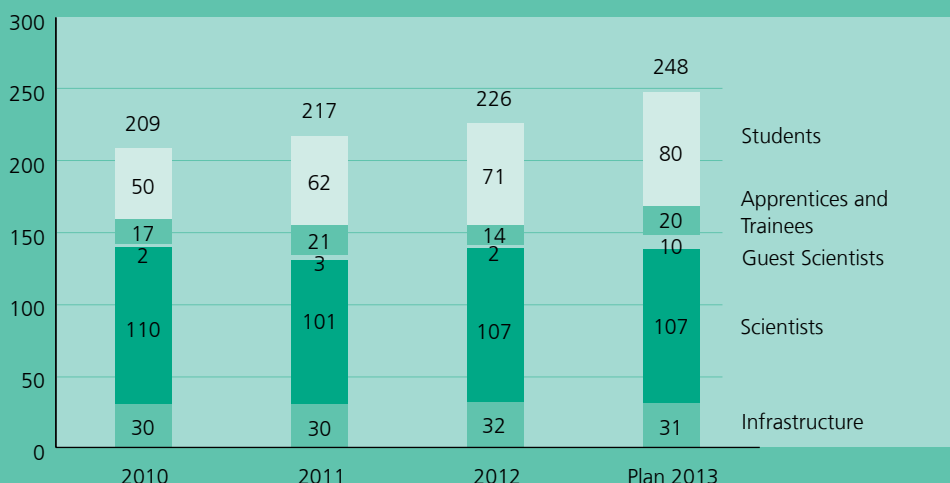



BUSINESS AREAS

The successful implementation of research results in innovative products requires building a solid bridge between technology-oriented researchers and product-oriented companies. Bridging this gap in the best possible way is the task of the business areas of Fraunhofer IESE. Standards, financial constraints and time restrictions, number of items produced, and many other impact factors differentiate areas of application that at first glance appear similar to those not familiar with these topics. Automobiles, a mass product, are produced in much greater quantities than, for instance, airplanes – which are an investment asset. In both cases, we are dealing with transportation systems, but the differences between them have far-reaching consequences regarding the suitability of methods and techniques in software and systems engineering. Business area managers have the broad view necessary to assess research results in terms of their use in specific application areas and to combine them in the best possible ways. Fraunhofer IESE is currently setting its focus on business areas that are important for both technical and business application areas.

Automotive and Transportation Systems	46
Automation and Plant Engineering	48
Medical Devices	50
Information Systems	52
eGovernment	54
Health Care	56

AUTOMOTIVE AND TRANSPORTATION SYSTEMS

Contact

Ralf Kalmar
Phone +49 631 6800-1603
Fax +49 631 6800-9 1603
ralf.kalmar@iese.fraunhofer.de



Ralf Kalmar

Software Technology for a World in Motion

Modern technologies for reducing consumption and increasing safety and comfort cannot be realized without electronics and software. The business area “Automotive and Transportation Systems” bundles the offers of Fraunhofer IESE particularly for users and manufacturers in the areas of automotive and rail vehicle manufacturing, aerospace, as well as commercial vehicles of all kinds. The term automotive software engineering comprises processes, techniques, methods, and tools adapted specifically to the requirements of vehicle technology.

The services of Fraunhofer IESE address development activities throughout the entire lifecycle, starting from automobile-specific process models on the basis of established standards (ISO/IEC 12207, ISO 26262) and the use of maturity level models (ISO/IEC 15504, Automotive SPICE, CMMI). Product planning is supported through software product line engineering and architecture standards (keyword: AUTOSAR), which take into account possible variants as well as technology and market requirements.

Special tasks such as configuration of a tool chain, integration of security and safety, or assessment of software product qualities (ISO/IEC 25000) are issues solved by Fraunhofer IESE, as are evaluation of innovative technologies in prototypes or systematic technology transfer for individual process steps.

Customer Benefits:

- Provable process and product qualities
- Adherence to safety and quality requirements
- Cost-efficient management of many product variants
- Competitive development productivity

Example Projects:

DENSO	p. 74
John Deere: TIA	p. 76
CESAR	p. 78
Bundeswehr	p. 80
Cyber-Physical Systems	p. 82
ARAMiS	p. 88
John Deere: Security	p. 94
Smart Farming	p. 102
Project Center Australia	p. 114
JAXA	p. 120

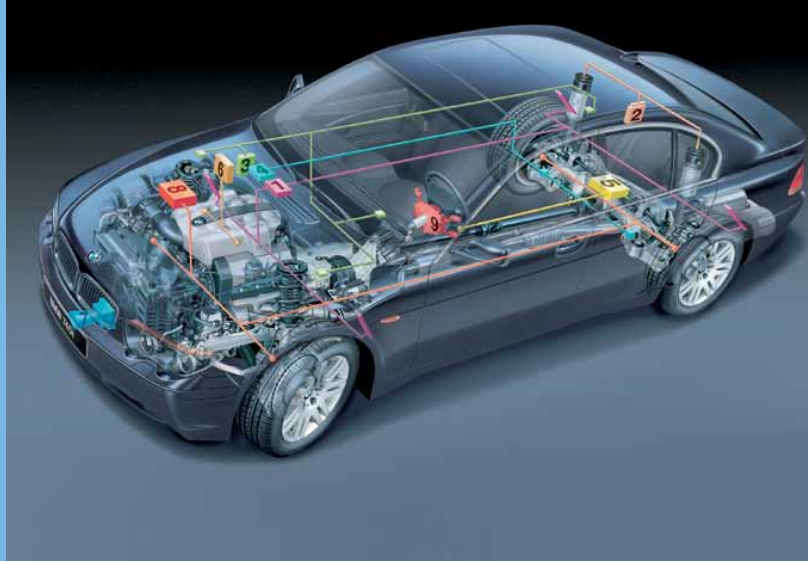

Competence in Software and Systems Engineering, Vertical Integration

Current and future systems are increasingly interconnected. The vertical integration from the IT system to the vehicle places high requirements on safety and reliability - a challenge that the software engineers of Fraunhofer IESE eagerly embrace.

SOFTWARE DEVELOPMENT

Requirements Management

We help you to structure even complex specifications and to ensure traceability in the process with tools such as DOORSTM.

Requirements Analysis, Specification-based Quality Assurance

We support you in developing high-quality requirements and specification documents and in mastering especially non-functional requirements.

Software Product Lines

We assist you in adapting software architectures to efficient reuse while taking advantage of cost- and quality-relevant effects.

Component Design

With our support, you can use efficient modern architectures and modeling languages such as Matlab® and develop runtime- or memory-critical applications without any problem.

SOFTWARE QUALITY MANAGEMENT

Process Assessments

We accompany you in planning and using data-based improvement programs on the basis of CMMIL and Automotive SPICE.

Software Architecture Evaluation and Restructuring

We support you in evaluating and restructuring your software architecture, taking into account special constraints such as runtime behavior or memory requirements.

Checking Techniques for Requirements, Design and Code

Software can already be checked before tested semi-automatically by using either appropriate models or performing structured reviews. We show you how to do this.

Software Measurement Systems

We make software quality measurable with systematically derived metrics - which means benefits for you.

Testing and Test Automation

Many tests can be automated and repeated. We support you in selecting and using appropriate methods, such as model-based testing.

Software Simulation

Testing a subsystem early in terms of its interfaces can be done via virtual integration and simulation.

Security Analyses

We perform thorough security analyses of your systems and help you to avoid vulnerabilities.

Safety Analyses

We design and support analyses for systems that must comply with defined requirements, e.g., in accordance with ISO /IEC 61508 or ISO 26262.

AUTOMATION AND PLANT ENGINEERING

Contact

Ralf Kalmar
 Phone +49 631 6800-1603
 Fax +49 631 6800-9 1603
 ralf.kalmar@iese.fraunhofer.de



Ralf Kalmar

Example Projects:

Bundeswehr p. 80
 Cyber-Physical Systems p. 82
 ECOJETROL p. 118

Modern Software Development

Decentralized and intelligent control systems, modular plants, small lot sizes, individual manufacturing according to customers' wishes, extensive variation management – the increasing ubiquity of PCs and wireless data transfer are just some of the trends in automation and plant engineering. Classical hardware tasks are increasingly taken over by software, partly for reasons of efficiency and costs, partly due to the necessarily higher complexity, which leaves no other choice than to shift functionality from hardware to software.

It goes without saying that quality must continue to be ensured in this transition: The high standards that have existed for decades in terms of the quality of machines, plants, and automation technology must also apply to software. Only if software is developed according to comparable, engineering-style principles can it conform to the high expectations of the plant engineering and automation industries.

Fraunhofer IESE as one of the worldwide leading research institutions in the area of software and systems engineering offers customers and research partners its expertise in the entire range of modern engineering-style software development. From embedded systems to interactive systems – Fraunhofer IESE studies, develops, and adapts software development processes, measurement methods, test procedures, and algorithms in order to realize innovative products for and with its customers.

Customer Benefits:

- Modern, engineering-style software development
- Adherence to safety and quality requirements
- Controllable complexity and measurable quality

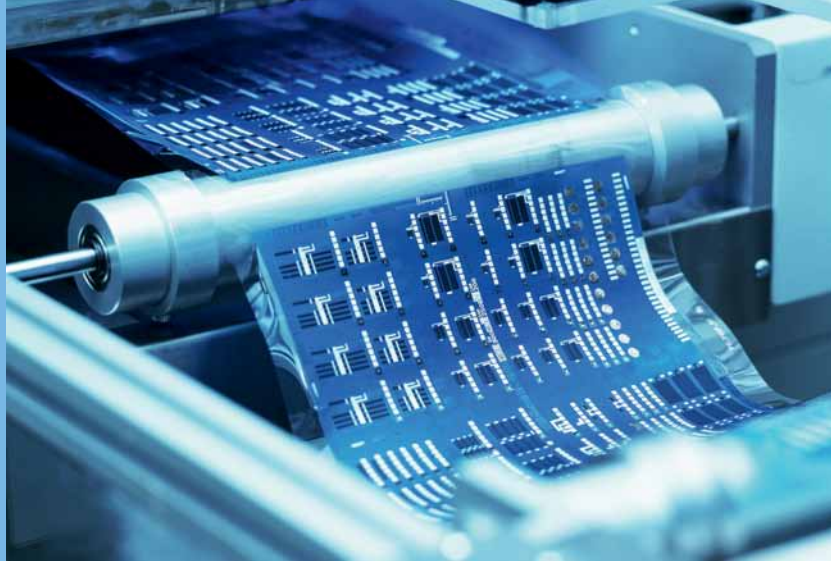

Competence in Software and Systems Engineering

Software engineering means developing software in an engineering-style, systematic manner in accordance with established or standardized processes and procedures. It allows measuring the quality of software and proving adherence to requirements, such as those regarding the safety and reliability of software-supported plants. Fraunhofer IESE offers the methodological competence, the creativity, and the spirit of research needed to develop modern concepts and innovative products with the help of software engineering.

SOFTWARE DEVELOPMENT

Our software and system construction offers you a variety of solutions that are easy to integrate and that will help you to ensure the required qualities during development already.

Software Product Lines

The product line approach PuLSE®, for instance, helps you to reduce unnecessary complexity in variant-rich systems, to make strategic use of reuse potentials, and thus to avoid expenses. Specific variants address special customer wishes – the challenge posed by the increasing complexity of your product world is met by Fraunhofer IESE with variation management processes.

Requirements Management

Incremental requirements engineering means you can be sure that requirements on new hardware and software versions will be elicited and assessed completely, in order to balance user requirements and company goals with the lowest possible change effort.

Usability Engineering

Professional usability engineering measurably increases the satisfaction of the users of your hardware and software by ensuring that the structure and design of user interfaces are oriented towards their requirements, tasks, and wishes. Fraunhofer IESE considers usability and user experience as a precisely specifiable construction goal.

Model-based Development

Continuously model-driven development with SysML or UML allows controlling complex systems with the help of view creation, automatic analyses, and code generation. We assess and restructure complex software and system architectures for you, taking into account non-functional characteristics as well.

SOFTWARE QUALITY MANAGEMENT

Test Automation

Continuous, especially automated testing in conjunction with systematic inspections optimizes quality assurance in the software development process and allows saving costs thanks to early elimination of defects.

Software Process Improvement

The range of services offered by Fraunhofer IESE also includes systematic SWOT analyses and evaluations of your development processes, proofs of process conformance, well-grounded safety analyses, as well as support in increasing your process maturity (CMMI, SPICE). We plan and implement improvement measures for you.

Software Measurement Systems

Through the use of defined metrics, which we derive in a systematic manner adapted to your demands, quality aspects can be expressed in concrete statements. Furthermore, we develop customer-specific software measurement systems and IT-Business Alignment measurement processes.

MEDICAL DEVICES

Contact

Ralf Kalmar
Phone +49 631 6800-1603
Fax +49 631 6800-9 1603
ralf.kalmar@iese.fraunhofer.de



Ralf Kalmar

Software-based Systems for Health and Quality of Life

The domain of medical devices faces particular challenges: The market demands innovative products in less and less time, which constantly increases the complexity and networking of the systems. Yet, absolute reliability and safety of the systems and the (embedded) software are required. There is hardly any other area of our daily lives where computer technology is so close to humans, and consequently, mistakes can have very serious effects.

Our software and systems engineering approach supports you all the way from the elicitation of requirements on the medical device to validation. Together with our customers, we develop innovative solutions for software development that efficiently fulfill the requirements of IEC 62304, DIN EN 60601-1-4, and ISO 12207, and provide assistance in systematically implementing them in daily practice. We integrate future-oriented methods and techniques that ensure quality requirements (e.g., in accordance with ISO/IEC25000 efficiently and economically). Safety is the top priority in this respect. We use new methods to support you in performing risk management according to ISO 14971 for software, and to use techniques such as Failure Mode and Effects Analyses (FMEA) and Fault Tree Analyses (FTA) for analyzing software safety. Custom-tailored quality management approaches (e.g., similar to ISO 13485) are defined as supporting processes.

Customer Benefits:

- Higher safety of the software and thus of the medical devices
- More efficient development and faster time to market
- Reduction of the development and quality assurance costs
- Measurable quality

Example Projects:

Cyber-Physical Systems p. 82
Project Center Maryland p.108
Project Center Brazil p. 116



Competence in Software and Systems Engineering

Fraunhofer IESE provides support for manufacturers of medical devices during all phases of software and system development.

SOFTWARE DEVELOPMENT

Requirements Management

We support you in eliciting requirements and in developing suitable requirements specifications as well as in managing the requirements.

Usability Engineering

With our expertise, we support you in ensuring that usability is considered during development, and in integrating it into the software and systems lifecycle (IAW EN 60601-1-6 and 62366).

System and Software Architectures

The specification and implementation of future-oriented architectures is one of our core competencies. This also includes the evaluation and restructuring of your existing software architecture, taking into account special constraints such as runtime behavior or memory requirements.

Software Product Lines and Reuse

We support you in defining and introducing the idea of software product lines, and in defining suitable and safe reuse concepts.

SOFTWARE QUALITY MANAGEMENT

Risk Management

The team of Fraunhofer IESE supports you in the standard-compliant implementation of ISO 14971 requirements by defining and implementing a risk management process for software that is adapted to your context and the corresponding documentation.

Safety Analyses

We help you to select and use adapted techniques such as FMEA, FTA, or introduce modern processes such as component fault trees in your organization.

Development Processes

We support you in the standard-compliant definition (e.g., IEC 62304, ISO 12207, V-Modell), structuring, documentation, and implementation of development processes and in the selection of methods, tools, and techniques that are suitable for passing certification procedures.

Static Quality Checking Techniques

Together with you, we define appropriate and innovative processes for verification in parallel to development.

Model-based Testing and Test Automation

We support you in the design and introduction of model-based testing techniques for embedded software, focusing in particular on test automation aspects.

Quality Management

We support you in defining, structuring, and establishing a standard-compliant quality management system for your software development in the style of standards such as ISO 9000-3 or ISO 13485, or the FDA Quality System.

Software Measurement Systems

Through the use of defined metrics, which we derive in a systematic manner adapted to your demands, quality aspects can be expressed in concrete statements.

INFORMATION SYSTEMS

FINANCE – ERP / SOFTWARE – TELECOMMUNICATION

Contact

Michael Ochs
 Phone +49 631 6800-1604
 Fax +49 631 6800-9 1604
 michael.ochs@iese.fraunhofer.de



Michael Ochs

Software in the Age of Information

Information systems permeate our daily lives in many areas. Especially in the areas of eCom-merce and eBusiness, we carry out many everyday tasks using online shops, auction platforms, or online banking systems. Company-internal information systems, in particular, such as ERP, CRM, accounting and billing systems support and automate business processes and thus per-form millions of transactions each day.

Neither operators nor users pay much attention to the technology of these highly complex soft-ware-based systems and their multiple interactions, and yet, modern business life is simply in-conceivable without functional, secure, and user-friendly software operating in the background. Using existing potential to increase efficiency and quality in the development and operation of information systems helps to optimize business processes in a sustainable and cost-efficient manner. Mobile services and applications as part of multi-channel strategies are an important means for making information available to customers and users independent of place and time and provide optimal and reliable support for their actions and decisions, which leads to a sig-nificant increase in flexibility and agility.

The services offered by Fraunhofer IESE range from development activities for large, heteroge-neous, distributed information systems via classical applications to mobile applications. This also comprises the design of systems on the level of coarse-grained and fine-grained requirements, taking into account non-functional requirements, usage designs that integrate business and user goals, User Experience design and (service-oriented) software architectures. Agile principles as well as innovative and proven state-of-the-art methods are also used here to increase the benefits for you as a customer. In quality management, Fraunhofer IESE is your competent and reliable partner for process management and optimization, governance and compliance topics, and the management of organizations and projects via key performance indicators (KPI) rang-ing from the strategic to the operational level. Here, too, we systematically integrate best prac-tices from the area of agile methods with best practices from proven standards such as CMMI®, V-Modell® XT, SPICE, and ITIL. Goal-oriented quality assurance through integrated inspections and testing as well as IT security audits and the definition of security concepts round off our portfolio of services.

Example Projects:

ICE-WISH	p. 90
Joint R&D Lab	p. 92
proALPHA	p. 96
IBIS	p. 98
Software-Cluster	p. 100
Smart Farming	p. 102
Project Center Australia	p. 114
ECOPETROL	p. 118

Customer Benefits:

- Provable product quality in all important aspects starting from the design phase already
- Competitive productivity for software and application development
- Optimized, controllable, agile, and risk-minimizing IT and software processes
- Controllable complexity of systems and applications



Competence in Software and Systems Engineering

Consistent and economical processes characterize the work of our institute, which transfers state-of-the-art validated scientific results in combination with best practices into industrial practice – information systems and processes in top quality, ready for the future.

INFORMATION SYSTEMS DEVELOPMENT

Requirements Specification and Management. In every other failed software project, some of the reasons for the failure can usually be found in the requirements. We support you in eliciting and specifying requirements on the basis of our proven approach Satisfy. This guarantees traceability and minimalist documentation of the necessary requirements decisions. In addition, functional as well as non-functional requirements are taken into account.

User eXperience. Today, good usability of information systems alone is no longer enough for achieving success among users. With our proven approach UXelerate, we support you, on the one hand, in evaluating existing systems and improving them based on such an analysis. On the other hand, we help you to develop information systems in such a way that the users have a positive User Experience.

Architecture-Centric Engineering. The architecture of your information system is the key to mastering complexity and to efficiently fulfilling many requirements. This is especially true for quality requirements and technical constraints. With our successful approach ACES we support you in defining and evaluating architectures even for complex information systems.

Business Goes Mobile. Multi-channel strategies and mobile services are becoming more and more important. We develop prototypes for mobile devices to help you make decisions and use these as a basis for developing an entire app. We are your competent partner for your mobile product and service strategy and for the selection of an adequate mobile software platform and development environment. Go mobile!

Variation Management. Complexity is often the result of a great multitude of variants and customer-specific configurations of software products. With our successful PuLSE™ approach, we support you in establishing, developing, and managing software variants.

SOFTWARE QUALITY MANAGEMENT

Process Management. Processes constitute a success factor for the quality of software. Based on a process analysis, we detect strengths and weaknesses in your processes so that improvement potentials and established best practices can be recognized. Actions for improving your processes can be defined systematically and can be implemented later on, which will increase the efficiency and quality of your processes in the long run.

Measurement, Key Performance Indicators, and Prediction Models. Transparency from the strategic to the operative level is an important factor for successful organizational control. We work with you on designing customized KPI systems that improve transparency and controllability – and enable you to predict certain attributes such as quality.

Effort Estimation and Benchmarking. We support you in estimating the effort required for your software projects, in identifying effort drivers, and in performing productivity benchmarking of projects. To do so, we use our proven CoBRA® method, which combines expert knowledge with measurement data and supports you in recognizing and controlling risks in a project early on.

Integrated Testing and Inspections. We help you to focus and reduce your testing efforts by coordinating testing activities with constructive activities such as requirements analysis. In addition, early quality assurance measures such as inspections provide important information on how to focus testing activities. We also support you in deriving test cases from requirements.

Security Audits and Security Concepts. Security standards such as PCI-DSS or IEC 15408 keep coming up with ever new requirements on systems and development. Security gaps must be avoided, since they result in a loss of trust and can negatively affect a company's business success. We define security concepts and evaluate systems and concepts in terms of relevant security requirements.

eGOVERNMENT

Contact

Thomas Jeswein
Phone +49 631 6800-2106
Fax +49 631 6800-9 2106
thomas.jeswein@iese.fraunhofer.de



Thomas Jeswein

Example Project:

P23R

p. 14

eGovernment Solutions for Public Sector and Business

The public sector with its more than four million employees represents one of the largest “business sectors” in Germany. It has to balance regulatory constraints, economic feasibility, and quality of service for its customers. Whether new IT solutions meet with success depends most of all on how well the public sector, business, government, and IT collaborate.

Whereas during the early years of eGovernment, the citizen as a customer of the public sector was the main focus of developments, recent years have seen a growing shift of this focus towards the interface between the public sector and business. This is where the highest gains in efficiency are expected.

ROI analyses performed prior to implementation projects ensure a project’s return on investment. Using systematic and integrated requirements management and involving all stakeholders early on creates the prerequisites for high acceptance of a system. The adaption of the process model V-Modell® XT to a development organization and support for a standard-compliant process ensure that projects are performed efficiently. Service-oriented, standards-based architectures allow the integration of legacy systems and guarantee reuse and interoperability.

Customer Benefits:

- Needs-oriented and secure software systems
- Implementation of eGovernment strategies on the basis of empirically determined priorities
- Asset protection through future-proof, interoperable technologies
- Transparent design and development decisions



Competencies in Software and Systems Engineering

Fraunhofer IESE assists partners from all levels of government and public institutions on their way to becoming a high-performance service provider for business and citizens. It provides advice to the public sector and to businesses on how to optimize their joint business processes, focusing on proving the benefits for the user. Concentrating on selected business sectors allows responding to their specific requirements and bundling online services in a way that is appropriate for each sector. A wide range of services provides support in planning and realizing needs- and future-oriented eGovernment solutions.

ROI Analyses

We use the screening method developed at Fraunhofer IESE to support you in identifying, evaluating, and prioritizing process chains between business and the public sector. Extended ROI analyses permit assessing the return on investment of an IT project. Effort estimates performed prior to development projects provide the basis for deciding whether to develop on one's own or join a development alliance.

Needs Analyses and Subcontractor Support

How well a system is oriented towards the demands of the user is a decisive prerequisite for how well it will be accepted later on. We support you in eliciting these demands by involving all stakeholders and in formulating the functional and non-functional system requirements. Based on these requirements, we develop bidding documents and provide support during the subcontractor process (esp. in accordance with the UFAB regulation).

Adaptation and Use of the V-Modell® XT

Applying the V-Modell® XT, which was developed with the participation of Fraunhofer IESE, increases the quality of project results while minimizing project costs and risks. We support you in successfully planning and performing projects in accordance with the V-Modell® XT. This also includes the adaptation of the V-Modell® XT to the specifics of your software development organization.

System and Software Architectures

The use of open standards in the context of Service-oriented Architectures (SOA) ensures the interoperability of your systems. We support you in designing and implementing future-oriented architectures and in evaluating and restructuring your existing software architecture. We develop organization-specific concepts for the introduction and operation of SOA.

Security

We support you in designing secure software systems, in checking system security in terms of compliance with BSI basic IT protection, and in planning and checking secure IT infrastructures, e.g., by simulating system attacks.

Usability

Deficiency analyses of your user interfaces based on known usability problems and pilot tests with users from representative user groups permit us to provide a solid empirical assessment of usability. Tests in our "Assisted Living Laboratory" allow us to evaluate the suitability of a given system especially for elderly people.

HEALTH CARE

Contact

Michael Ochs
Phone +49 631 6800-1604
Fax +49 631 6800-9 1604
michael.ochs@iese.fraunhofer.de



Michael Ochs

Example Project:
ONKOPTI

p. 86

Software Technology for Innovative Health Care

Our health care system is currently undergoing dramatic changes. The demographic development, the scarcity of public funding concomitant with the increasing demand for health services, a rapidly developing information and communication technology, and last but not least, regulatory requirements stipulated by law create challenges for the system on various levels.

The use of information technology in the health care sector aims at digitally linking all stakeholders and processes in health care. This includes both software-based applications and the process workflows supported by them.

Modern information systems effectively support automated data elicitation and communication processes and thus make a major contribution to improving quality and increasing efficiency in health care.

Fraunhofer IESE provides support to all stakeholders in the health care sector when it comes to developing and testing software-based innovations. The institute assists its customers from the health care domain in developing complex information systems as well as in implementing domain-specific requirements on modern process management.

Customer Benefits:

- User-oriented software systems
- Controllable complexity and variants
- Provable safety and quality requirements
- Provable process and product quality



Competence in Software and Systems Engineering

The development and quality assurance of software using established methods and standardized software engineering processes form the basis for innovative software systems in health care.

SOFTWARE DEVELOPMENT

Requirements Analysis and Management

We support you in developing high-quality requirements and specification documents. The renowned requirements approach Fraunhofer TORE guarantees that you will get traceability, already integrated usability, and minimal documentation of the necessary requirements decisions.

Usability and User Experience

We optimize the usability of your systems already during development or detect weak spots in the finished product. Using our proven methods, we collaborate with you on developing systems that not only provide support for the user, but also deliver a positive User Experience. This is beneficial for the user, but has also been proven to further the business goals of your organization, and thus will contribute to long-term business success.

Architecture-Centric Engineering

With our successful Fraunhofer ACES approach, we support you in defining and evaluating architectures for complex information systems. The iterative, scenario-based procedure allows you to master the complexity of architecture definition and migration and to make reliable predictions regarding critical system properties early on.

Software Product Lines

With our PuLSE® approach, we support you in defining and introducing the concept of software product lines and in defining suitable and safe reuse concepts. PuLSE® helps you to reduce the unnecessary complexity of systems with many variants, make strategic use of reuse potentials, and thus avoid excess costs.

SOFTWARE QUALITY MANAGEMENT

Checking Techniques for Requirements, Design, Code

We enable early quality assurance for your documents in the software development cycle through the use of the Fraunhofer tool DETECT in order to avoid cost-intensive rework in a later development phase.

Quality Management

We support you in defining, structuring, and establishing a standard-compliant quality management system for your software development in the style of standards such as ISO 9000-3 or ISO 13485 or the FDA Quality System.

Safety Concepts

We support you in determining your safety requirements in terms of pertinent guidelines and standards and define infrastructure and software concepts together with you, or assess existing systems and concepts in terms of the relevant safety requirements and standard compliance.

Improvement Programs based on Measurement Data

In cooperation with you we determine the potential need for optimization in your development processes on the basis of empirical findings. This makes it possible to capture and assess even such aspects as method efficiency and acceptance, which are otherwise hard to specify quantitatively.



DEPARTMENTS

The divisions and departments of Fraunhofer IESE are the central pillars on which the institute’s research topics are based. One division combines work on Embedded Systems, while another one encompasses activities in the area of Information Systems. For many industry partners, in particular, this structure makes it easy to find an ideal match with the structure of Fraunhofer IESE. Since Embedded Systems and Information Systems are merging into Cyber-Physical Systems and whole areas of our lives are experiencing comprehensive “computerization” in the sense of “Smart Ecosystems”, we must also increasingly deal with cross-cutting issues. This is where processes are of crucial importance, the area of research of our Process Management division.

The divisions Embedded Systems and Information Systems are each divided into two departments focusing on development methodology on the one hand and quality assurance on the other hand. This division corresponds to the structures found in industry and therefore facilitates direct bilateral collaboration. The division Process Management is divided into a department focusing on processes and another department focusing on measurement. This structure reflects the importance of suitable process contents on the one hand and their quantitative monitoring on the other hand.

DIVISION EMBEDDED SYSTEMS	61
Embedded Systems Development (ESD)	62
Embedded Systems Quality Assurance (ESQ)	63
DIVISION PROCESS MANAGEMENT	65
Measurement, Prediction and Empiricism (MPE)	66
Process Compliance and Improvement (PCI)	67
DIVISION INFORMATION SYSTEMS	69
Information Systems Development (ISD)	70
Information Systems Quality Assurance (ISQ)	71

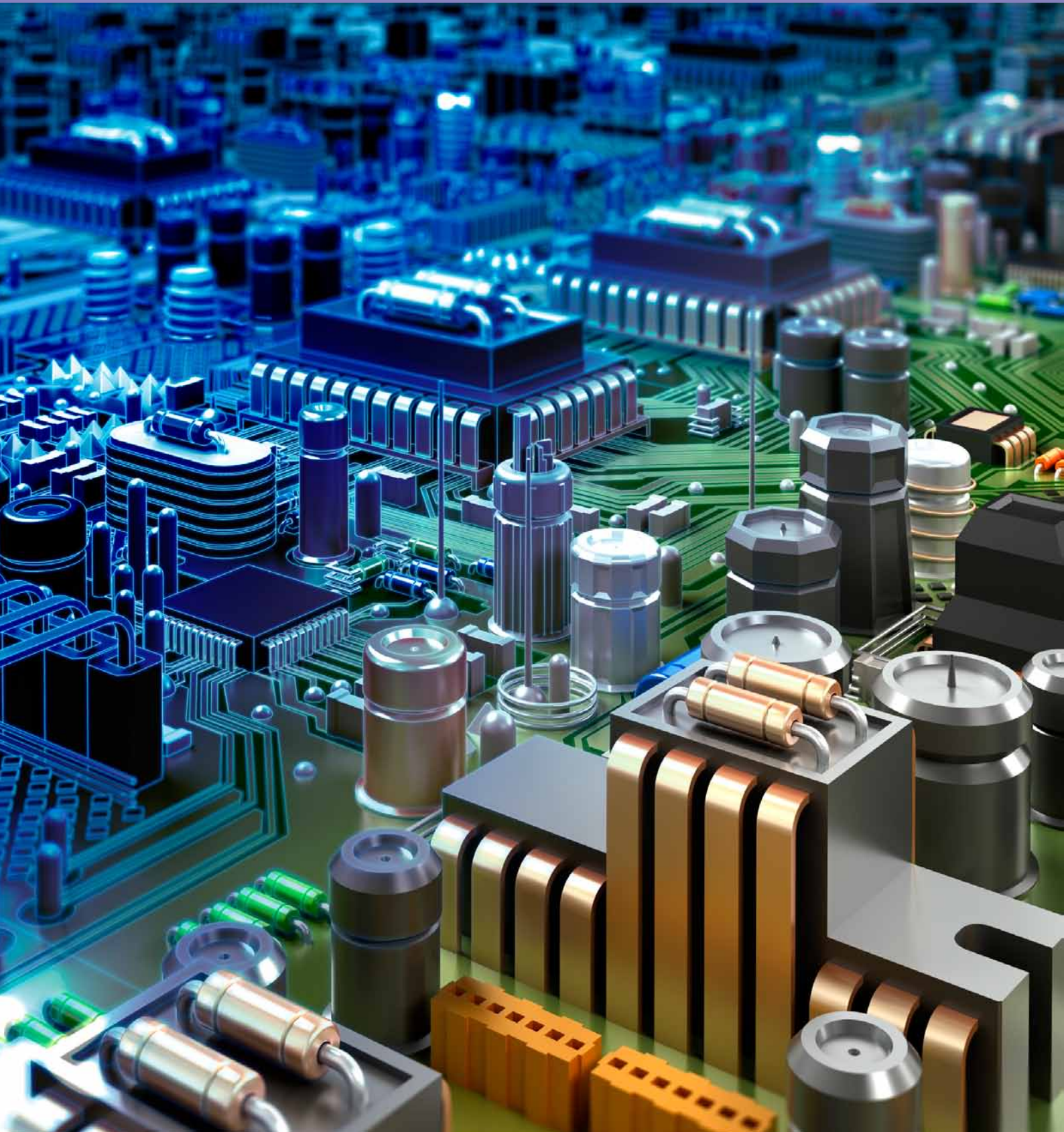

DIVISION EMBEDDED SYSTEMS

Hidden in transportation systems, medical devices, consumer goods, and almost all other technical products, embedded systems are performing essential tasks that make our daily lives safer and more comfortable. Every year, more than three billion embedded components and devices are manufactured, incorporating 98% percent of all microprocessors built. Embedded systems are omnipresent, and our modern economy and society would be unable to survive without them.

The requirements on the reliability and functional safety of such systems are correspondingly high. Failures can rarely be tolerated – particularly when such failures might jeopardize people or the environment. At the same time, the complexity of these systems is increasing ever faster. They are tightly interconnected, developed in a distributed manner, and have to fulfill numerous, sometimes contradictory, functional and non-functional requirements.

In order to meet these challenges, the division “Embedded Systems” focuses on innovative methods and techniques for developing highly reliable and safe systems in a cost-efficient manner.

Division Head

Dr. Mario Trapp
Phone +49 631 6800-2272
Fax +49 631 6800-9 2272
mario.trapp@iese.fraunhofer.de



Dr. Mario Trapp

Example Projects:

DENSO	p. 74
John Deere: TIA	p. 76
CESAR	p. 78
Bundeswehr	p. 80
Cyber-Physical Systems	p. 82
ARAMiS	p. 88
Smart Farming	p. 102
SW Archit. Seminars	p. 104



Department Head

Dr. Martin Becker
 Phone +49 631 6800-2246
 Fax +49 631 6800-9 2246
 martin.becker@iese.fraunhofer.de



Dr. Martin Becker

EMBEDDED SYSTEMS DEVELOPMENT (ESD)

In order to be able to develop such highly reliable and safe systems in a cost-efficient manner, development must focus on system quality right from the outset. This means that efficient support is needed for the developers to allow them to keep track of everything, despite rapidly increasing system complexity, and to make the right decisions based upon facts. The ESD department supports its customers during the entire development cycle from requirements to implementation.

■ Model-based Development

If we want to model not only software, but entire systems including the relevant non-functional properties, “off-the-shelf” products often do not suffice. When it comes to selecting, adapting, and combining suitable languages and tools, the experts of Fraunhofer IESE will provide comprehensive support for model-based development.

■ Architecture Development

The system architecture influences quality and development costs across system generations. Systematic processes in combination with automated, tool-supported architecture analyses and simulations make it possible to assess existing architectures and to identify and assess possible architecture variants early on. Architecture faults can thus be avoided proactively already during development.

■ Variation Management

Embedded systems are often not single products, but rather product families. They must be extensible and changeable throughout their lifetime. The strategic planning of system variants and modifications enables reuse rates of over 90%. Thus, system quality increases while costs and development times decrease. The ESD department supports its customers with efficient methods for variation management – from the initial potentials analysis to the introduction of customized solutions in the organization.



EMBEDDED SYSTEMS QUALITY ASSURANCE (ESQ)

To ensure product quality, a major portion of the development costs is invested into quality assurance. Complex systems, in particular, call for efficient methods that make high quality requirements achievable and reduce quality assurance costs at the same time. The ESQ department offers its customers cost-efficient methods that allow determining a system’s quality effectively and verifiably.

■ **Safety Engineering**

Fraunhofer IESE is one of the leading institutions in the area of functional safety. Our spectrum of services ranges from the introduction and implementation of all safety activities via hazard and risk analyses to safety cases. Process efficiency is particularly important in the development of software-intensive systems. By using innovative and largely automated processes, the IESE safety experts support their customers in developing even highly safety-critical systems efficiently.

■ **Model-based Testing**

Important keys to reducing costs include early performance and automation through tests. The test experts of IESE support their customers in performing model-based tests that employ automatically generated test cases to check the system already during early development phases. This saves not only costs and time, but also makes it possible to quantify the system’s quality and thus make quality statements that stand up to scrutiny.

■ **Static Analyses**

Efficient quality assurance is characterized by the fact that products are not only tested, but also checked with the help of static analyses. On the one hand, this means manual inspections; on the other hand, it implies automatic checking of source code or models. The ESQ department develops innovative, cost-efficient procedures and supports its customers in performing static analyses effectively.

Department Head

Sören Kemmann
 Phone +49 631 6800-2218
 Fax +49 631 6800-9 2218
soeren.kemmann@iese.fraunhofer.de



Sören Kemmann

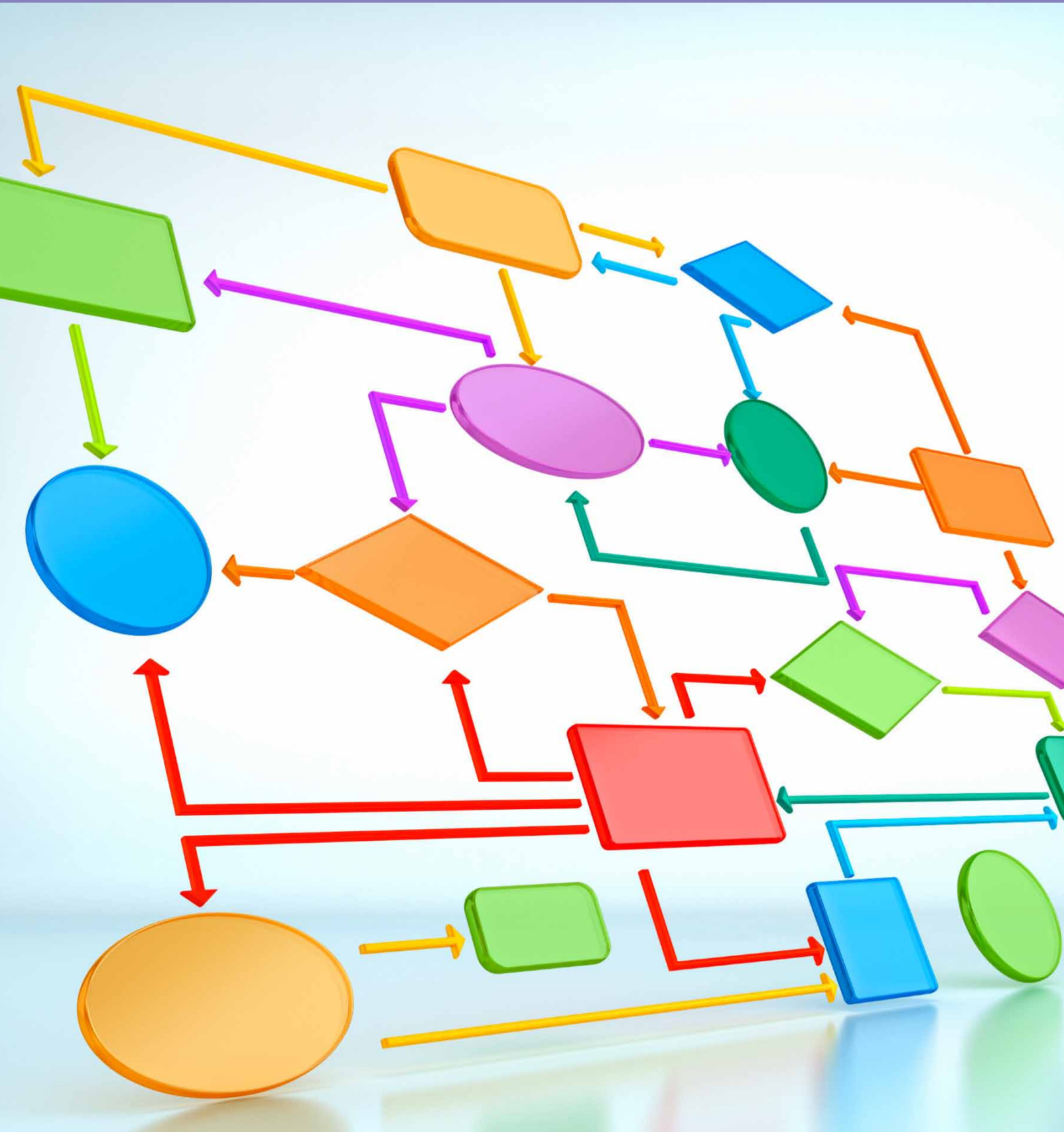

DIVISION PROCESS MANAGEMENT

Processes are the core of software and systems engineering. They are an important prerequisite for managing large software and IT projects and expedite the successful realization of software innovations. High product quality is the result of high-quality processes.

Mastering and improving processes is a great challenge. In order to achieve positive effects on products and business goals, processes must be goal-oriented, efficient, and verifiable, and must be based on solid experience. We support organizations in implementing domain-specific requirements on modern process management and in evaluating software-based innovations.

Goal-oriented measurement processes, customized process techniques, advanced prediction techniques, and technology evaluations are key parts of our service portfolio. The primary goal is to link processes and their intended effect. The benefit is a significant increase in the contributions of software and IT to an organization's business performance.

References

Ericsson uses the measurement approach GQM+Strategies® of Fraunhofer IESE to model the goals and strategies of a software development unit in an integrated manner and to control it with appropriate measurement systems. For this purpose, the approach was integrated into the goal specification process and adapted to the needs of Ericsson. The adaptation of the approach led to a more accurate specification of the goals and to integrated alignment of the goals and strategies on different levels of the organization. By systematically deriving an integrated measurement system, significant improvements could be achieved in terms of monitoring goal achievement and assessing the success or failure of a strategy. The transparent documentation of goals, strategies, and appropriate measurements also provided support for the effective communication of goals and strategies within the organization.

Software systems in the space industry are subject to special quality requirements – in a collaboration project with the Japanese space agency JAXA, Fraunhofer IESE is working on the definition of appropriate development processes. In addition, Fraunhofer IESE has produced a customized process model (SETG) of the relevant European ECSS Standards for Software Development and Software Management for the European Space Agency (ESA).

Division Head

Dr. Jens Heidrich
Phone +49 631 6800-2193
Fax +49 631 6800-9 2193
jens.heidrich@iese.fraunhofer.de



Dr. Jens Heidrich

Example Projects:

Bundeswehr	p. 80
Cyber-Physical Systems	p. 82
Project Retrospectives	p. 84
ONKOPTI	p. 86
ARAMIS	p. 88
ICE-WISH	p. 90
proALPHA	p. 96
Software-Cluster	p. 100
Smart Farming	p. 102
ECOPETROL	p. 118
JAXA	p. 120

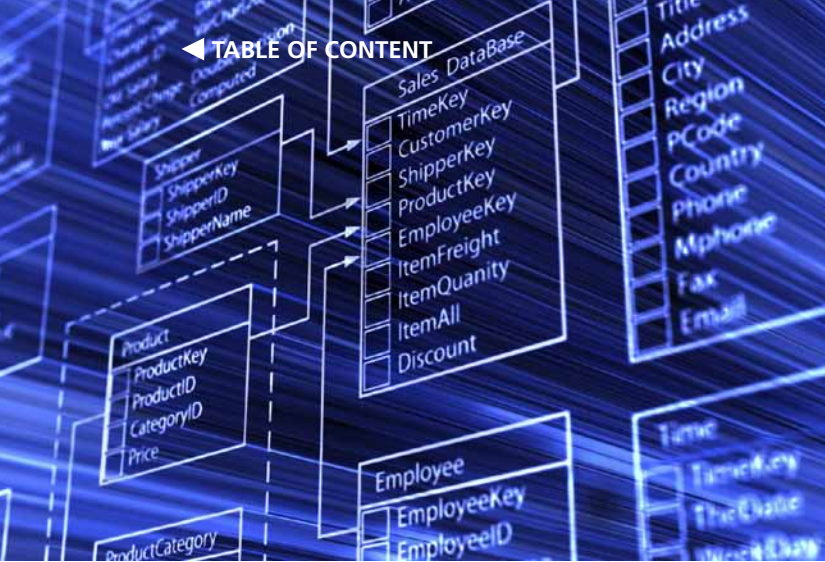

Department Head

Dr. Andreas Jedlitschka
 Phone +49 631 6800-2260
 Fax +49 631 6800-9 2260
 andreas.jedlitschka@iese.fraunhofer.de



Dr. Andreas Jedlitschka

MEASUREMENT, PREDICTION AND EMPIRICISM (MPE)

In order to develop software-intensive systems and services that fulfill all given requirements and that are delivered on time and within budget, engineering-style processes are indispensable. This includes the definition and establishment of suitable measurement systems, measurement-based controlling and evaluation of products, processes, and techniques, as well as systematic use of data for prognoses and process optimization. The practice-oriented work of the department MPE focuses on the following core topics:

- **Measurement and IT/Business Alignment**
 We develop measurement systems and bring transparency to the development so that possible problems can be identified early on, risks can be minimized, and the quality of products and processes can be improved with lasting effects. We use measurement techniques to systematically align software and IT strategies with organizational goals and to achieve a clear value orientation of an organization's IT.
- **Cost and Effort Estimation as well as Sizing**
 We develop prognoses early on and determine the functional scope of software. This makes it easier to assess offers and project costs and to avoid project risks.
- **Quality Modeling and Defect Management**
 We develop customized quality models for evaluating software quality characteristics and establish integrated defect management.

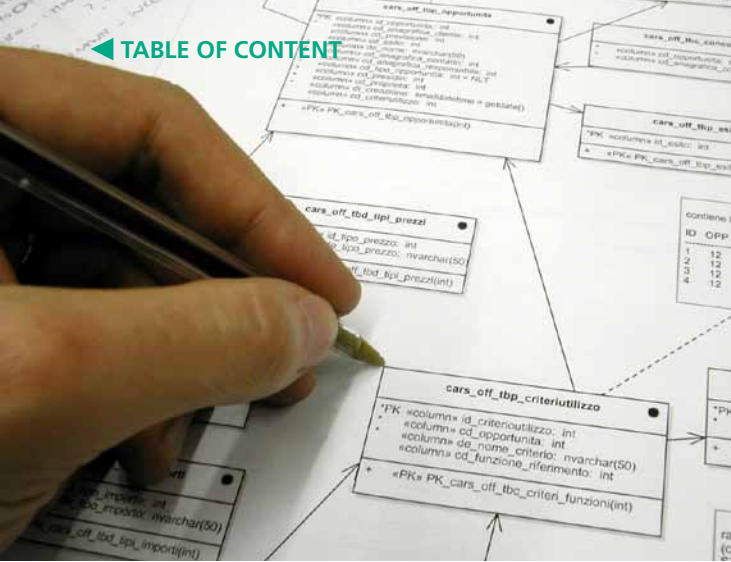

PROCESS COMPLIANCE AND IMPROVEMENT (PCI)

Processes are the driving force in the value chain of modern organizations. However, benefits can only be generated if processes are also accepted and lived. Thus, it is important to not only create process handbooks, but also to monitor the implementation and evolution of processes in daily practice. Furthermore, it must be possible to prove adherence to requirements on processes that have been accepted as binding requirements. The focus of the department PCI is on the following topics:

- **Modeling, Documentation, Evolution, and Introduction of Processes**
We support you in establishing lean, modifiable processes that are guaranteed to be compliant with relevant standards.
- **Process Analyses, Audits, Assessments, and Compliance Management**
Adherence to standards such as Automotive Spice or ITIL is required in many areas. We support you by performing gap analyses, help you to prepare for audits and assessments, teach special in-house training seminars, and assist you in fulfilling compliance requirements.
- **Evidence-based Process Improvement**
We offer you a simple starting point for reliably identifying improvement potential in your processes and for continually optimizing your processes, with special emphasis on the evaluation of process performance and on the ROI of improvement measures.

Department Head

Rolf Hendrik van Lengen
 Phone +49 631 6800-2103
 Fax +49 631 6800-9 2103
 rolf.van.lengen@iese.fraunhofer.de



Rolf Hendrik van Lengen



DIVISION INFORMATION SYSTEMS

Modern information systems and interactive systems are becoming ever more complex. Hype topics such as service orientation or cloud computing as well as increasingly mature technologies including those in the area of mobile end devices further increase the complexity of these systems. The challenges that our customers often face are the result of multi-dimensional project settings with many stakeholders, interests, and systems as well as the complex workflows of one or several networked companies. Other typical challenges include complex user interfaces, ensuring and verifying required system qualities, and last but not least, the multitude of variants and configurations of our customers' systems.

The division Information Systems develops innovative methods and solutions for the development of complex information systems and interactive systems. In order to offer an immediate added value, we apply our methods directly during our customers' product development and/or transfer our methods and solutions to our customers. These include organizations that use software solutions for their business processes, e.g., from the banking and insurance sector or from the domain of medical IT systems, organizations from such areas as public administration and defense, as well as software developing companies (both large corporations and SMEs).

Division Head

Dr. Jörg Dörr
Phone +49 631 6800-1601
Fax +49 631 6800-9 1601
joerg.doerr@iese.fraunhofer.de



Dr. Jörg Dörr

Example Projects:

DENSO	p. 74
Cyber-Physical Systems	p. 82
Joint R&D Lab	p. 92
John Deere: Security	p. 94
proALPHA	p. 96
IBIS	p. 98
Software-Cluster	p. 100
Smart Farming	p. 102
SW Archit. Seminars	p. 104

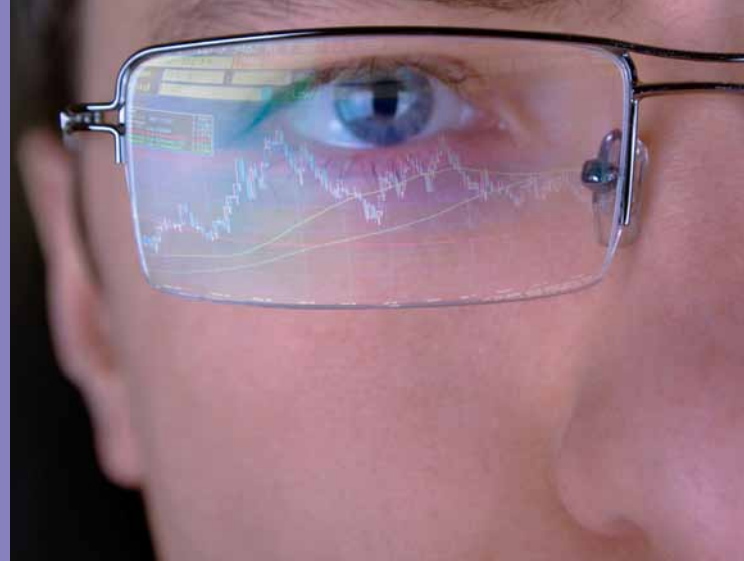

Department Head

Dr. Marcus Trapp
 Phone +49 631 6800-2186
 Fax +49 631 6800-9 2186
 marcus.trapp@iese.fraunhofer.de



Dr. Marcus Trapp

INFORMATION SYSTEMS DEVELOPMENT (ISD)

We address challenges arising during development early and continuously with the help of constructive, innovative development approaches and methods, from requirements elicitation via architecture to design. Our strength lies in examining the non-functional (quality) requirements, which are hard to capture and often affect the entire system. Clearly defined software development artifacts with clearly defined levels of abstraction allow focusing on what is really important and interlink with both traditional and agile process models.

■ **Requirements Engineering**

With our renowned requirements approach Fraunhofer Satisfy, which is custom-tailored to your requirements, we integrate requirements engineering and constructive usability in the context of modern information systems, addressing issues such as lean and agile development, user-centered and innovative software, standard-compliant procurement (especially in eGovernment), as well as organization-wide business process management (BPM). The approach offers traceability throughout and minimal documentation of the necessary requirements decisions, and hence adds value to a project right from the start.

■ **User Experience for Business Applications**

With our proven methods we support you in developing systems that not only support their users, but also allow having a positive User Experience. This has been proven to contribute to the achievement of your business goals.

■ **Architecture-Centric Engineering**

With our successful Fraunhofer ACES approach, we support you in defining and evaluating architectures for complex information systems. The iterative, scenario-based process allows you to master the complexity of architecture definition and migration and to make reliable predictions regarding critical features of the system early on.

■ **Product Line Engineering**

Our successful approach Fraunhofer PuLSE™ supports you in establishing, developing, and managing a software product line as well as in analyzing and improving your already existing configuration infrastructure for variant-rich information systems.

■ **Business Goes Mobile**

With our approach GoMobile we help you to exactly identify those areas where a mobile app makes sense as support for your business processes. We can also develop a prototype that can be executed on various mobile devices to help you make your decisions.



INFORMATION SYSTEMS QUALITY ASSURANCE (ISQ)

In addition to the constructive activities needed to achieve the required product quality, efficient and effective methods are needed for quality assurance. The department ISQ offers its customers cost-efficient methods for validating the required system quality. One special focus is on the quality of security, which is becoming increasingly important for networked information systems.

■ Integrated Testing

Many projects expend more effort on testing activities than necessary. Fraunhofer IESE focuses testing effort by aligning and integrating testing activities with preceding software development activities such as requirements analysis, but also with inspections. Our support includes training and technology transfer, evaluation of existing testing processes, support during testing, and test case derivation.

■ Tool-supported Inspections

Defects that remain undetected until the testing phase cause unnecessary costs. Inspections permit performing quality assurance of your documents early in the software development cycle. We support our customers' inspectors by using the Fraunhofer tool DETECT to perform efficient manual evaluation of your development documents. DETECT offers suitable reading support, can be customized to individual quality features, and teaches the inspectors expert knowledge. Last but not least, DETECT generates clearly structured defect reports.

■ Security Audits and Definition of Security Concepts

Security gaps in IT systems can cause serious damages and the ensuing loss of trust can negatively affect business success. We support our customers in determining their security requirements regarding pertinent guidelines and standards. For our customers' projects, we define security concepts for infrastructure and software or perform tool-supported assessments of existing systems and concepts in terms of relevant security requirements and standard compliance.

■ Usage Control for Distributed Data

To protect private users or company-related information from data misuse, e.g., in the form of identify theft, disclosure of strategic business data, and image loss due to privacy violations, simple forms of access control are no longer sufficient. Fraunhofer IESE therefore relies on innovative mechanisms for data usage control. By using predefined policies for data usage and modifications to the used and involved IT systems, it can be monitored and ensured that the data can only be used in accordance with rules (so-called policies) that have been specified by you.

Department Head

Michael Eisenbarth
 Phone +49 631 6800-2181
 Fax +49 631 6800-9 2181
michael.eisenbarth@iese.fraunhofer.de



Michael Eisenbarth



PROJECTS

A large number of third-party funded projects with industry for transferring innovative methods into practice and publicly funded projects for establishing new competencies are characteristic of the application orientation of Fraunhofer institutes. With all three of its divisions, Fraunhofer IESE has established itself as a strategic and dependable partner both in public programs and in major industries.

In the public sector, Fraunhofer IESE plays a leading role in important major projects. In the area of Embedded Systems, these include the BMBF projects ViERforES for the development of graphical metaphors for the visualization of quality aspects of large software systems as well as ARAMiS for the development of demonstrably safe multi-core-based software solutions. In the area of Information Systems, the Software-Cluster "Software Innovations for the Digital Enterprise" aimed at the development of interoperable, adaptive, and secure software in support of business processes is the main focus. In these public projects, we are also collaborating closely with industry partners. Beyond that, the Fraunhofer-Gesellschaft is investing internal funds to establish competencies in the area of data security (Attract), while continuing its commitment in the areas of commercial vehicles (Innovation Cluster DNT) and acceleration of know-how transfer from the University of Kaiserslautern to Fraunhofer IESE (Innovation Center Applied System Modeling).

Direct industry projects exist with leading companies in Germany's major industries. Examples include John Deere GmbH & Co. KG in the commercial vehicle sector, DENSO GmbH in the automotive supply sector, or proALPHA Software AG in the software product sector. Projects with small and medium-sized enterprises (such as Insiders Technologies GmbH) are another focal point of our work. Our commitments abroad are steadily growing as well (e.g., JAXA in Japan, ECOPETROL S.A. in Colombia, or Murex S.A.S. in Brazil). A special focus is on collaboration projects in Brazil in the area of medical devices as well as on collaboration projects in Australia in the area of logistics.

DENSO: Control as a Service – How Suitable are the Technologies of Today for the Car of Tomorrow?	74
JOHN DEERE: Efficient TIA Safety	76
CESAR: Automatically Optimized Deployment of Software Functions to Flight Computers	78
BUNDESWEHR: Systems Engineering for the Multi-Role Combat Ship 180	80
Innovation Center Applied System Modeling: Cyber-Physical Systems	82
Project Retrospectives	84
ONKOPTI: Oncological Therapy Protocols on the Internet	86
ARAMiS: Process Configuration Framework	88
ICE-WISH: 15% Less Energy and Water Consumption through Innovative Information Technology	90
INSIDERS TECHNOLOGIES: Joint Research & Development Lab	92
JOHN DEERE: Secure Software Engineering for Embedded Systems	94
proALPHA: Test Process Improvement with Metrics	96
IBIS: Designing Intuitive Use with Image Schemata	98
SOFTWARE-CLUSTER: The Next Generation of Enterprise Software	100
Innovation Center Applied System Modeling: "Smart Farming" Living Lab	102
FRAUNHOFER ACADEMY: Software Architecture Seminars – Expert Knowledge from the Source	104

DENSO: Control as a Service – How Suitable are the Technologies of Today for the Car of Tomorrow?

Contact

Dr. Jens Knodel
 Phone +49 631 6800-2168
 Fax +49 631 6800-9 2168
jens.knodel@iese.fraunhofer.de



Dr. Jens Knodel

Collaboration Partner

DENSO CORPORATION
<http://denso-europe.com>



The “Cloud” provides computing resources as a service over a network (e.g., the Internet). Using cloud services is common practice for users with web browsers on mobile devices such as smartphones and tablets and enables access to business applications or lifestyle applications.

But how suitable is cloud computing for other domains? Which role could it play for the next computing platform for automotive control software? How suitable are today’s technologies for enabling “Control as a Service” – real-time controlling of a car by cloud/virtualization techniques through wireless communication? And last but not least, what might a system architecture look like which would enable control as a service?

Delivering answers to these research questions is the goal of the collaboration between DENSO CORPORATION (the major Japanese supplier for automotive components and solutions) and Fraunhofer IESE. The feasibility study serves as preparation for the development of a proof-of-concept prototype:

- DENSO and Fraunhofer IESE have characterized the required (base) technologies and elicited important related functional and non-functional requirements for advanced use cases to enable the scenario “Control as a Service”. Requirements have been captured using architecture scenarios.
- Fraunhofer IESE has conducted technology surveys on cloud computing, wireless communication and protocols as well as relevant standardization efforts and research projects. The survey provides an assessment of today’s technologies and their suitability for tomorrow’s application scenario (i.e., Control as a Service). The elicited requirements served as evaluation criteria for the assessment and the results provided insights into the extent to which today’s technologies can serve the needs of tomorrow.
- Based on the results, Fraunhofer IESE and DENSO designed the conceptual architecture design for “Control as a Service”. On the one hand, the architectural decisions made serve as preparation for the proof-of-concept implementation. The prototype realizes the architectural concepts and demonstrates the feasibility of Control as a Service. On the other hand, the architecture provides a reference guide for future engineering of the system.

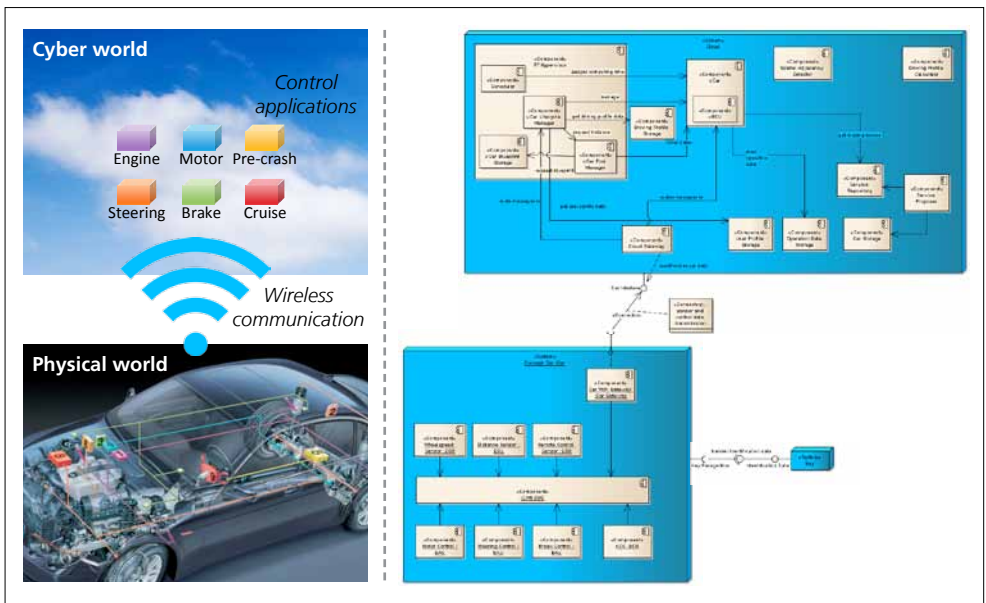

Conceptual architecture design of the next computing platform for automotive control software: Left: conceptual building blocks Right: system architecture structure (excerpt)

Applying the Fraunhofer IESE approach for designing architectures allows exercising control over the inherent complexity of the system – in this case the cloud, the car, and their real-time interactions. The architecture provides the necessary abstraction to realize the proof-of-concept, separates the stakeholder concerns, and balances the technical constraints, the technology impact, and the requirements.

“The collaboration with Fraunhofer IESE helped us to assess the new possibility of future automotive control applications. Their professional competence has clarified the feasibility of this novel concept, and their holistic methodology of architecture design has brought it to the real world. We learned a lot from Fraunhofer IESE through fruitful discussions and would like to continue our good relationship to enhance this study for years to come.”

Dr. Masakazu Adachi, Technical Research, DENSO AUTOMOTIVE Deutschland GmbH

Further Reading:
 Business Area Automotive and
 Transportation Systems p. 46
 Division Embedded Systems p. 61
 Division Information Systems p. 69

JOHN DEERE: Efficient TIA Safety

Contact

Daniel Schneider
Phone +49 631 6800-2187
Fax +49 631 6800-9 2187
daniel.schneider@iese.fraunhofer.de



Daniel Schneider

Collaboration Partner

John Deere
www.johndeere.com



Safety in Open Systems

In recent years, a strong trend towards an opening of (embedded) systems could be observed across a wide variety of application areas, which is very likely to further increase in the next few years. Overall, development is moving towards open, distributed, heterogeneous, and adaptive systems of systems, which is also underscored by certain paradigms gaining increasing importance, such as that of Cyber-Physical Systems.

In the agricultural sector, in particular, such tendencies have been observed for quite some time already. Under the umbrella term “precision agriculture”, various sources of information, such as device-specific sensors, GPS, and satellite images have long been combined with IT services to optimize productivity and efficiency in all regards. In order to generate further benefits for the customers, attempts have recently emerged to further increase the degree of automation on the field – up to and including autonomous operation! A prominent example in this regard is Tractor Implement Automation (TIA).

TIA allows an agricultural implement to control central parameters of a tractor, such as driving speed, steering, or the tractive unit. This allows automating workflows and optimizing a multitude of agricultural processes. Since in terms of technology, TIA is based on the standardized data bus ISOBUS, the foundation exists for flexible coupling of agricultural implements from different manufacturers and thus for offering the greatest possible benefit to the customer. Such an “open” design of the system, however, would result in exorbitant costs, especially due to the challenge of guaranteeing functional safety in all conceivable cases. Currently, John Deere is examining every possible combination of tractor and implement separately in order to guarantee the safety of that particular integrated system. Opening up in terms of a combination with any agricultural implement would, however, multiply the number of possible tractor-implement combinations by orders of magnitude, which would also increase the costs for safe development enormously. For this reason, the TIA technology is currently only available to selected manufacturers of agricultural implements.

Efficient Safety Guarantees through Conditional Modular Certification

In the context of this project, the goal is to design an approach that is suitable for efficiently guaranteeing the safety of modular and open TIA systems. For the core concept of the approach, Conditional Safety Certificates (ConSerts) were used. ConSerts offer safety-relevant

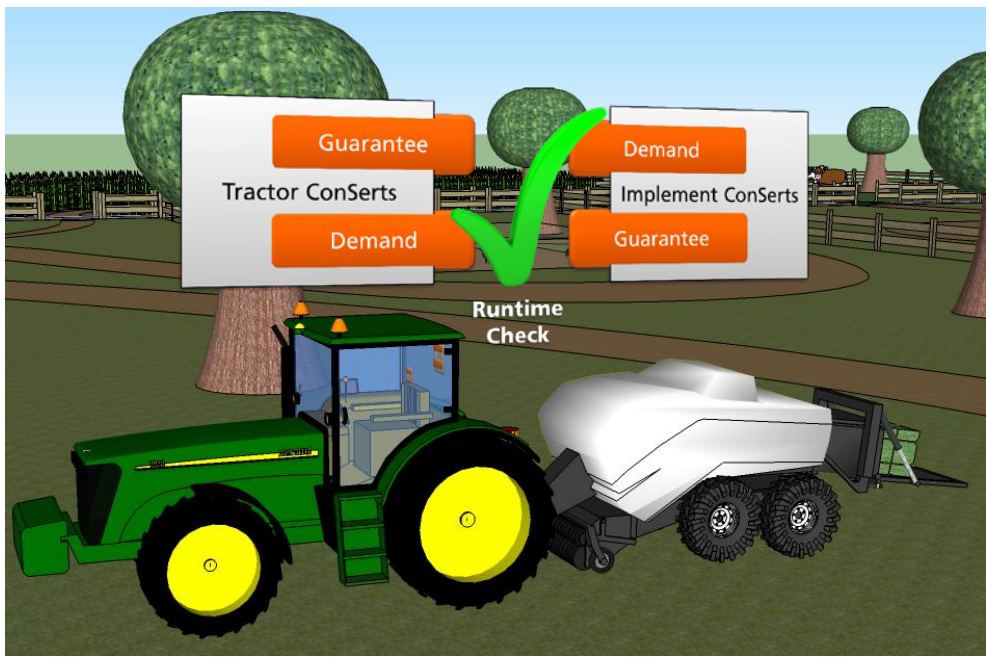

The conditions of the modular certificates refer to “Guarantee-Demand” dependencies between implements in particular and on the environment in general. The check is performed at the time of integration.

guarantees dependent on corresponding requirements on the environment. This environment includes, in particular, other interacting implements as well as information on the topology of the terrain or the presence of people in the work area. At the time of integration, the ConSerts of all participating systems are composed and evaluated in order to establish a valid certificate of the current overall system. The applicability of this concept for a domain does, however, depend on several factors, such as the standardization of the interfaces (as already given in part by the ISOBUS), including the safety-related guarantees and requirements. For this purpose, the TIA domain was analyzed in the project and a “Safety Domain Model” was sketched, which allows the use of ConSerts. In addition, engineering approaches were designed that support the development of such a domain model on the one hand and the conditional certification of concrete systems on the other hand.

For 2013, a follow-up project is planned that will build on the lessons learned.

Further Reading:

- Business Area Automotive and Transportation Systems p. 46
- Division Embedded Systems p. 61
- Smart Farming Living Lab p. 102

CESAR: Automatically Optimized Deployment of Software Functions to Flight Computers

Contact

Dr. Thomas Kuhn
Phone +49 631 6800-2177
Fax +49 631 6800-9 2177
thomas.kuhn@iese.fraunhofer.de



Dr. Thomas Kuhn

Further Information

Project Homepage
www.cesarproject.eu



Artemis Joint Undertaking Grant
Agreement Number: 100016

FUNDED BY



Bundesministerium
für Bildung
und Forschung

Grant no. 01IS09005H

Software regulates and controls a wide variety of aspects in avionics. Software components realizing functions that have a direct impact on flight-relevant actuators such as elevator and rudder are especially critical. Each of these functions must communicate with a multitude of sensors and actuators in order to be able to fulfill its respective task.

The software components are executed by flight computers. The IMA (Integrated Modular Avionics) platform ensures that several functions can be executed on the same hardware without interfering with each other. In addition, the IMA guarantees adherence to time thresholds and offers a standardized interface between software functions and the hardware.

During the deployment process, a decision is made as to which software component will be executed on which flight computer. In this context, different aspects need to be taken into account:

- Functions have different requirements regarding the necessary memory and the necessary CPU time.
- Functions must communicate with sensors and actuators. Allocating a function to a specific computer means that the relevant sensors are connected to this computer.
- A sufficient number of interfaces of each required type must be available on the computer in order to establish the connection with the sensors and actuators.
- Functions also communicate with other functions. If two functions are executed on different computers, additional time for communication must be taken into account.
- Furthermore, constraints must be considered as well; these are specifications stating that certain functions must not be executed on a computer or only under certain conditions.

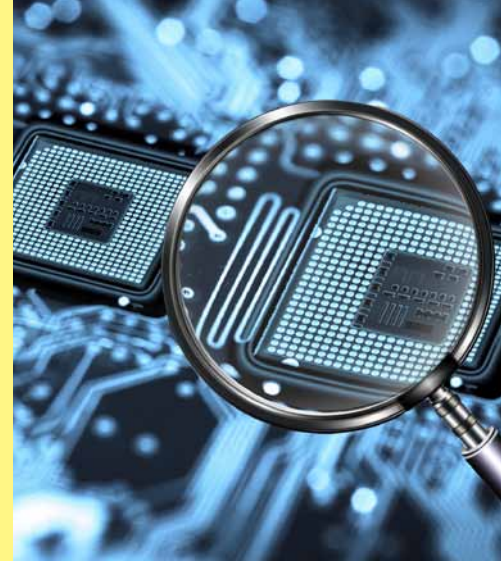

In the context of this research project with Airbus Operations GmbH, an approach was developed for the model-based description of functions, computers, and constraints. Additionally, a process was developed that automatically distributes software functions to computers and optimizes this distribution on the basis of defined specifications and criteria. For this purpose, an ILP (Integer Linear Programming) optimizer was connected with a UML/SysML modeling tool.

This tool integration allows automatic transformation of the system model into an optimization problem. Developers and engineers thus do not have to deal with the details of the linear equation systems that the ILP optimizer is working with. Instead, they can focus on the description of the system. Deployment proposals are automatically calculated by the ILP optimizer from the system model; the developers can see the effects of design decisions and can assess these early on and correct any mistakes.

“The decomposition and allocation of system functions to the Airbus IMA platform is tied to numerous additional conditions and dependencies due the complexity of our systems, and is therefore very effort-intensive. The optimization tool prototype developed by us in collaboration with Fraunhofer IESE realizes concepts of a model-based specification with assessment methods and automated optimization.”

Dietmar Sander, Airbus Operations GmbH, Hamburg

Several thousand software functions make it possible to operate an Airbus A380 safely.

Collaboration Partner

Airbus Operations GmbH
www.airbus.com

Further Reading:

Business Area Automotive and
Transportation Systems p. 46
Division Embedded Systems p. 61

BUNDESWEHR: Systems Engineering for the Multi-Role Combat Ship 180

Contact

Dennis Landmann
Phone +49 631 6800-2100
Fax +49 631 6800-9 2100
dennis.landmann@iese.fraunhofer.de



Dennis Landmann

Collaboration Partners

BAAINBw
www.baain.de

Marine
www.marine.de

The multi-role combat ship (MRCS) 180 of the German Bundeswehr, whose planning began in 2011 with the development of a first requirements specification, is particularly characterized by its high operational flexibility, which shall be achieved via the concept of mission modularity. On the one hand, the description of the capabilities needed for this purpose and the derivation of requirements and design specifications are strongly influenced by proven processes, regulations, and technologies. On the other hand, innovations in various aspects shall be introduced for the first time in the future MRCS 180 project. These include, among others:

- Application of the V-Modell XT: This will be the first time where the V-Modell XT BW 1.3 shall be applied from the start to a complete ship development and construction project. Compliance with the V-Modell is sought in all phases.
- Requirements-driven procedure: From the determination of missing capabilities via the definition of usage scenarios to the system requirements and component requirements, the goal is to elicit, analyze, and specify a completely traceable requirements specification. Requirements management compliant with V-Modell XT as well as problem and change management shall be established right from the start.
- Overall system modeling: The MRCS180 system (several marine units, various land support facilities, the associated processes) shall be modeled in a solution- and manufacturer-neutral way down to a level that allows making detailed technical specifications regarding functions and qualities.

Compliance with the V-Modell XT

From the beginning, the MRCS180 project is applying the most recent version that is applicable for the Bundeswehr (V-Modell XT 1.3 BW). The consistent application of the V-Modell will be conducive to the transparency of the procedure and will allow potential contractors to prepare accordingly.



Requirements-driven Procedure

This will be the first time that the requirements on the MRCS180 system will be elicited in a systematically traceable way and building upon one another. In a first analysis phase, a capability profile was established, which shows the capability gap that the system is supposed to fill and describes the main functional usage requirements. After the transition to a pilot project of the new, amended Customer Product Management of the Bundeswehr, the functional requirements were elicited on the basis of the capability profile. Building on this, in the second analysis phase a technical requirements specification will be developed that is systematically traceable to the required functional properties and that will serve to develop the proposed solutions. In the second analysis phase, requirements specifications and technical specifications that build upon one another will be developed to allow examining the extent to which the proposed solutions cover the capability and requirements catalog and to prepare support for the selection. The elicitation, management, and quality assurance of the requirements will be supported by a suitable methodology provided by Fraunhofer IESE.

System Modeling

Several novel requirements entail major changes to the infrastructure and the ship layout. These include, e.g., intensive usage (longer idle times during deployment and at sea) or a reduced manning concept. The implementation of these requirements shall be supported by consistent modeling oriented towards a newly created system perspective and using an industry-oriented modeling language. In the project, the SysML language is being used together with a systems engineering methodology of Fraunhofer IESE.

Frigate Mecklenburg-Vorpommern

© Bundeswehr/Winges

Further Reading:

Business Area Automotive and
Transportation Systems p. 46

Business Area Automation and
Plant Engineering p. 48

Division Embedded Systems p. 61

Division Process Management p. 65

Innovation Center Applied System Modeling: Cyber-Physical Systems

Contact

Dr. Thomas Kuhn
Phone +49 631 6800-2177
Fax +49 631 6800-9 2177
thomas.kuhn@iese.fraunhofer.de



Dr. Thomas Kuhn

Further Information

Project Homepage
www.applied-system-modeling.de



innovationszentrum
applied system
modeling



Fraunhofer



Rheinland-Pfalz

MINISTERIUM
FÜR BILDUNG, WISSENSCHAFT,
WEITERBILDUNG UND KULTUR

Nowadays, embedded systems perform their services as closed units. Frequently they are developed for precisely specified use cases as units consisting of hardware and software.

Future embedded systems, however, will be open and have interfaces with which they can interconnect with other embedded systems. Such systems are called Cyber-Physical Systems. Through their open interfaces, they participate in scenarios and offer new functions that could not be foreseen yet during the development of the individual systems. This leads to entirely new challenges regarding the development methods and tools used for these systems.

In the context of the Innovation Center Applied System Modeling, we are performing research on new technologies for the development of future Cyber-Physical Systems in order to make these as reliable and as safe as current systems. The topic areas we are working on include:

- Simulation of communication systems: In this project, the simulation framework of Fraunhofer IESE is being extended with components for the simulation of a wide variety of communication systems. These play an important role in the development of Cyber-Physical Systems, since communication systems have a significant impact on the reliability of communication, on the security of the data transmission, and on the delay of the transmitted data. In this context, we are also studying novel communication concepts specifically for Cyber-Physical Systems.
- Virtual prototypes: In addition to communication, the hardware platform of a system also plays a great role. In this area, we are therefore studying different ways of executing software on simulated hardware, addressing particularly early development steps where the specifications are still incomplete and where no operating systems might be present yet.

This project is being funded by the Fraunhofer-Gesellschaft and by the State of Rhineland-Palatinate.

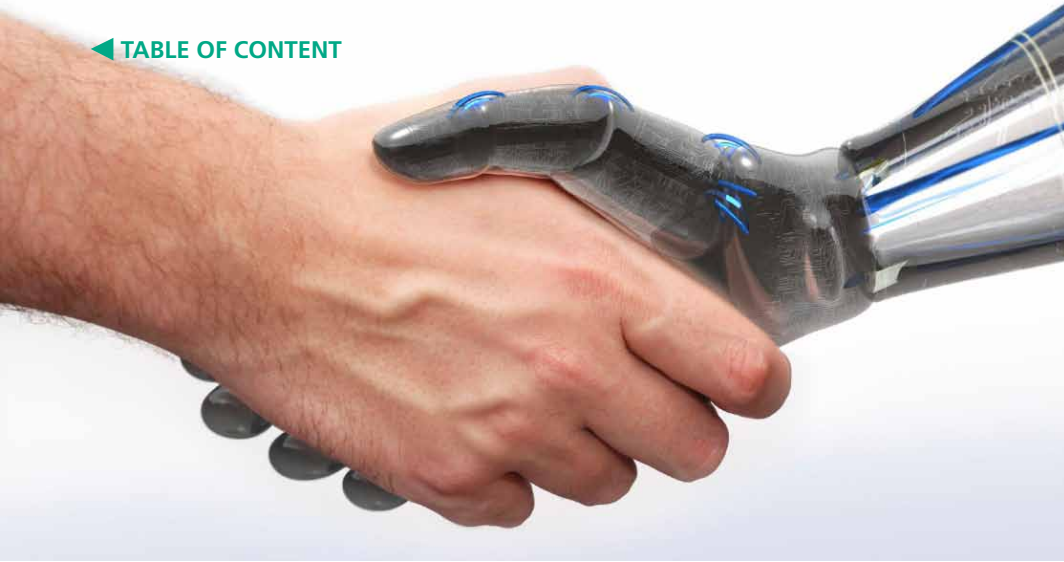

- **SafeCar:** In order to simplify the certification of safety-relevant systems, we are studying a functional cage for software. In contrast to virtual machines, which protect host systems from untrustworthy software, our cages monitor the function of the software and initiate countermeasures as soon as an unsafe behavior is observed.
- **SEAD:** This sub-project focuses on agricultural aspects. The goal is to provide a platform and the interfaces and context sources (such as weather information) needed for introduction to the market that will dynamically offer services (by including farmers, manufacturers of agricultural machinery, fertilizer and seed producers, as well as data providers) to optimize the farmers' work on the field (see page 102).
- **Cloud Computing:** In this topic area, we are studying Cloud technologies. Cyber-Physical Systems will move various tasks to a Cloud, since sufficient computing time cannot always be provided locally. This requires new concepts for safeguarding data security and ensuring scalability of these systems.
- **Go Mobile:** Mobile devices will also play a significant role – either as a hardware platform for Cyber-Physical Systems or as a user interface. In this topic area, we are studying novel concepts for the development of graphical user interfaces and their scaling to various types of end devices.

With the help of these different topic areas, we are performing research into a novel platform for the development of safety-relevant Cyber-Physical Systems.

Collaboration Partner

University of
Kaiserslautern
www.tu-kl.de

Further Reading:

Business Area Automotive and Transportation Systems	p. 46
Business Area Automation and Plant Engineering	p. 48
Business Area Medical Devices	p. 50
Division Embedded Systems	p. 61
Division Process Management	p. 65
Division Information Systems	p. 69

Project Retrospectives

Contact

Dr.-Ing. Andreas Jedlitschka
Phone +49 631 6800-2260
Fax +49 631 6800-9 2260
andreas.jedlitschka@iese.fraunhofer.de



*Dr.-Ing. Andreas
Jedlitschka*

Situation

Although many projects are successful in terms of content, they fail when it comes to constraints such as budget, time, and required quality. Typical reasons for such failures are bad communication, bad preparation, insufficient consideration of project risks, lack of resources, ambiguous goals, and misunderstood roles.

A retrospective helps to systematically identify problems and potential, and to derive improvement measures from the lessons learned. This will allow your company to save time and money in current and future projects and to achieve the required quality in a more determined manner.

Every project, regardless of whether it is more or less successful, provides you with insights on how to sustainably improve the processes followed by your team or your company in developing and delivering values for your customers. This is what we call Lessons Learned.

Systematically capturing lessons learned and implementing the derived improvement measures in a sustainable manner is the basis for successful projects.

Retrospectives

For ten years, Fraunhofer IESE has been performing retrospectives in various domains for companies and projects of various sizes. Our proven method has helped to develop solutions for better communication structures between customer and contractor, for general project processes and role definitions from the launch of a project to its conclusion, as well as for mutual understanding.

Our retrospectives are done externally and are therefore objectively moderated work groups. In the context of a retrospective, the project members explicitly study your project in order to identify what went well and what should be improved next time. We use modern moderation methods to support your team in deriving improvement measures for your company, starting from the project history via success and failure stories to an objective analysis of the causes.



Retrospectives can be performed at any time. In the context of milestones or iterations, the results (such as improved communication) can be implemented directly in the project. As an additional benefit, retrospectives quite often have the positive side-effect of a team development measure.

To identify the improvement potential of your future projects, we recommend concluding every one of your projects with a retrospective. If you do this, your company will create the basis for the establishment of a “Learning Organization”.

Result

Our retrospectives help you identify lessons learned from your projects and package them in such a way that they can be used for the sustainable improvement of your current and future projects. As the direct work result of a retrospective, you will get:

- Identified lessons learned. We support your team in identifying effects and investigate the causes. Together with your team we elicit what went well and what should be improved next time. The results of this work form the basis for improving your ability to create quality within a given budget and deliver it on time.
- Derived action plans. Lessons learned are only as good as the change they are initiating. With our support, your team will define work steps, assign responsibilities, and suggest a schedule for implementing improvement measures. The coordinated action plans ensure that the changes will actually be implemented. This helps to repeat success and avoid mistakes.

The retrospectives of Fraunhofer IESE – the cost-efficient way to extract valuable lessons learned from your projects. Lessons learned will sustainably increase the efficiency and effectiveness of your projects.

Further Reading:

Division Process Management p. 65

ONKOPTI: Oncological Therapy Protocols on the Internet

Contact

Rolf Hendrik van Lengen
Phone +49 631 6800-2103
Fax +49 631 6800-9 2103

rolf.van.lengen@iese.fraunhofer.de



Rolf Hendrik van Lengen

Further Information

Project Homepage
www.onkopti.de

Collaboration Partners

Westpfalz-Klinikum GmbH
Medizinische Klinik I
Prof. Dr. Hartmut Link
www.westpfalz-klinikum.de

Deutsche Krebsgesellschaft
AG Internistische Onk-ologie

Prof. Dr. Irene Krämer
Apotheke der Universitäts-
medizin Mainz

In medicine, the treatment of malignant tumors is called oncological therapy. The treatment options include primarily the removal of the diseased and the surrounding tissue, radiation of this tissue, as well as medication and/or supportive treatments. Depending on the patient's general health condition, these different therapies are also frequently combined with each other.

In the field of oncology, therapy protocols of original work, guidelines, instruction manuals, collections of protocols, study groups, and conference proceedings are generally used for the medicated treatment. It is extremely complex and time-consuming to update these and/or to create completely new protocols. The implementation of continuous and numerous innovations in the area of oncological therapy into clinical standards therefore usually only succeeds with major time delay. In addition, there is a lack of central quality assurance and a working variation management of the therapy protocols used in clinical routine work.

On behalf of the Department of Internal Medicine I of the Westpfalz-Klinikum regional medical center in Kaiserslautern, Fraunhofer IESE has designed and implemented the information system ONKOPTI, which provides the clinical oncologist with up-to-date, editorially selected data from oncological routine and/or study protocols for solid tumors and hemoblastoses on the Internet. In addition, all information that is relevant for the protocol, such as literature, guidelines, studies, technical information, etc. is captured and displayed upon demand.

The information needed for creating a protocol is stored in a database. Basic information such as medication, diseases, literature references, and Internet links is managed by the user in about 30 basic tables. With the help of these data, the expert can generate protocol modules, which can then be reused as quality-assured modules in many protocols. Examples include drug-based tumor therapy, accompanying and supportive therapy, hydration, check-ups, etc. Subsequent changes to a module require all therapy protocols using this module to be re-validated completely. A complete therapy protocol then consists of elements from the basic tables and one or several protocol modules.

Web-based entries in the protocol as well as their quality assurance are made by experienced oncology, hematology, and pharmacy specialists, who check the data in terms of content and form in an editorial workflow involving professional associations, experts, and study groups. After successful validation, the protocol is then released for use.



ONKOPTI - Onkologische Therapieprotokolle im Internet

Substanzen bearbeiten

Diesen Datensatz löschen

Substanzname: Cisplatin
 Abkürzung: Cis
 Stoffgruppe: Alkylanzien/Platinderivate
 Substanzklasse: Zytostatika

Kontrolle	Indikator	Anpassung
GFR	Niereninsuffizienz	Die Nephrotoxizität ist dosislimitierend, dosisabhängig und kumulativ. Dispositionsfaktoren sind Hyperurikämie oder Hypoalbuminämie. Eine forcierte Diurese darf auf keinen Fall mit Schleifendiuretika durchgeführt werden.
Thrombozyten	Knochenmarkinsuffizienz	Ein Therapiekurs sollte erst bei Werten ab > 100000/µl durchgeführt werden.
Leukozyten	Knochenmarkinsuffizienz	Ein Therapiezyklus sollte erst bei Leukozytenzahl > 4000/µl durchgeführt werden.
Na ⁺ , K ⁺ , Ca ²⁺ , Mg ²⁺	None	Normwerte vor Therapieeinleitung erforderlich.
Linksventrikuläre Pumpfunktion, Echokardiographie	None	Gute LVF erforderlich aufgrund des erforderlichen hohen Flüssigkeitsumsatzes

Klinische Parameter, sonstige Modifikationen:
 Audiogramme müssen vor der Behandlung und vor jedem neuen Zyklus aufgenommen werden. Vor, während und nach der Verabreichung sind neben den og. Parametern folgende zu überprüfen: Hämatoese (Leuko.- Thrombo.- und Erythrozyten), Mg im Serum (s.o.) Ein Therapiekurs sollte erst nach Erreichen folgender weiterer Laborparameter erfolgen: Serum-Kreatinin

Editor for capturing all relevant information about a substance, shown on the example of Cisplatin, a well-known cytostatic drug

A protocol can be looked at in different views, or it can be printed. The selection includes a mini-version that is freely available on the Internet, a short protocol, an overview schema, as well as an extensive version, which only differ in terms of the degree of detail of the information listed. For the therapy of a patient, an application protocol can be generated as an Excel document with individual daily schedules and the necessary medication.

Further Reading:

- Business Area Health Care p. 56
- Division Process Management p. 65

ARAMiS: Process Configuration Framework

Contact

Dr.-Ing. Andreas Jedlitschka
Phone +49 631 6800-2260
Fax +49 631 6800-9 2260
andreas.jedlitschka@iese.fraunhofer.de



*Dr.-Ing. Andreas
Jedlitschka*

Coordinated development processes play an important role in the modern world of software engineering, particularly in large projects. The most frequent case is that the individual processes being used (e.g., for the creation of the design document or for the conduction of system tests) are discussed by the company's experts in coordination with various stakeholders, such as the project managers and the developers. Alternative technologies are discussed and selected, and the overall process is determined. But what happens when no experts are available, or if there is no time to perform these steps manually?

These issues are to be addressed by the Process Configuration Framework, which is being developed in the context of the project ARAMiS (Automotive, Railway and Avionics Multicore Systems) and which realizes a process framework. The solution to the problem is based on a technology repository containing uniform descriptions of the technologies. This repository is a collection of technologies covering a specific software development phase or aspect. It can be used for a given project as a basis for assembling a specific project process out of the different technologies. This is done in the framework via three subsequent phases:

- Technology assessment
- Linking / combination of technologies
- Process configuration

Technology Repository

The basis of the process framework is a technology repository that specifies all the technologies in a generic schema. This represents a platform for (new) technologies. The goal is to use it as a basis for selecting the best suitable technologies for the process. The schema that is used here consists of a technology model, a context model, and an impact model. In addition to the actual description of the technology, these models include the context in which the technology was used, and the impact in this context. The three models were developed on the basis of a multitude of empirical studies, interviews, etc.

This schema is the most important basis for the three phases of the approach, since it defines the various elements and attributes and allows assessing and combining the technologies.

Further Information

Project Homepage
www.projekt-aramis.de

ARAMiS

FUNDED BY



Bundesministerium
für Bildung
und Forschung

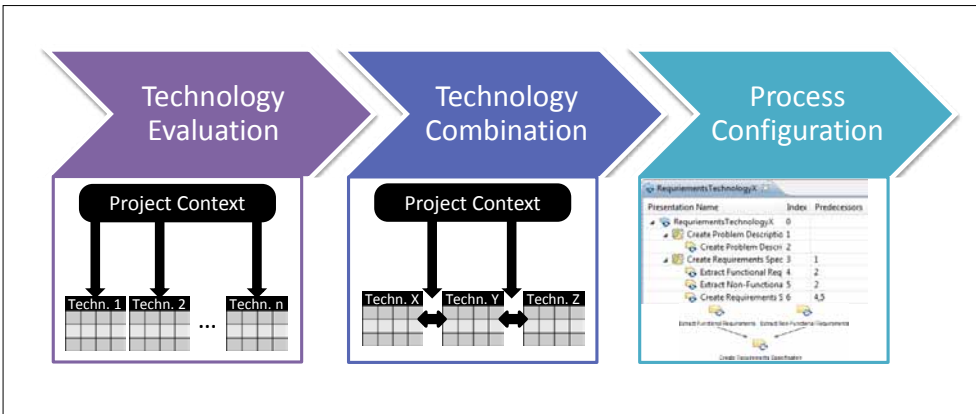

Set-up of the Process Configuration Framework

Right: represents the assessment of technologies based upon the project context

Center: represents the combination of technologies to form a chain

Left: example of a SPEM process pattern for a technology

Technology Assessment and Combination of Technologies

The empirically based technology schema allows assessing the individual technologies depending on the characteristics given by a specified software project and finding the best possible combination for the respective project. The combination is performed according to rules that compare the technology information stored in the schema with the characteristics of the project.

Process Configuration

The configuration of the process is modeled with the help of SPEM, a process modeling language, and a process pattern is provided for each technology. An individual process can then be developed from these patterns together with the technology combination.

For 2013, we plan to further extend and evaluate the approach in a real application environment in the context of the ARAMIS project.

Collaboration Partner

see Project Homepage
www.projekt-aramis.de

Further Reading:

- Business Area Automotive and Transportation Systems p. 46
- Division Embedded Systems p. 61
- Division Process Management p. 65

ICE-WISH: 15% Less Energy and Water Consumption through Innovative Information Technology

Contact

Dr. Martin Wessner
Phone +49 631 6800-2118
Fax +49 631 6800-9 2118
martin.wessner@iese.fraunhofer.de



Dr. Martin Wessner

ICE-WISH stands for “Demonstrating through **I**ntelligent **C**ontrol (smart metering, wireless technology, cloud computing, and user-oriented display information) **E**nergy and **W**ater wastage reductions **I**n European **S**ocial **H**ousing”. In this European demonstration project, 19 partners from ten countries are developing and testing an innovative technical solution for social housing that shall allow conserving at least 15% of the energy and water consumption in the long term, without compromising living conditions. The solution is being tested during a period of twelve months in 300 social dwellings in ten European countries.

ICE-WISH enables the residents to see their current usage on their TV screen and compare it to either their own previous usage or the usage of similar apartments. They receive both general information and advice on how to conserve energy (electricity, gas, district heat) and water (cold and hot water) and information and advice that is tailored to their own usage behavior. In addition, they can check the effects of their usage behavior and possible changes of this behavior on their budget with ICE-WISH. At the same time, ICE-WISH captures the indoor climate (indoor temperature, humidity, CO₂ content of the air), with the intent to ensure that conservation is not achieved at the expense of living comfort. To do all this, ICE-WISH relies on a combination of intelligently interconnected digital energy and water meters, information packaging that is optimally tailored to the residents, and state-of-the-art approaches for usage analysis and prediction. This forms the basis for residents to understand their usage behavior and to develop sustainable behaviors for conserving energy and water without compromising living conditions. Aggregated analyses provide building managers with additional information on how to energetically improve their buildings.

Further Information

Project Homepage
www.ice-wish.eu



This project is being partially funded by the European Union in the context of the Information and Communication Technologies Policy Support Programme (ICT PSP) as part of the Competitiveness and Innovation Framework Programme.

During the three-year runtime of the project, the first step was to elicit and assess the requirements of the building management and the residents as well as the respective technical and structural conditions. The next step was to specify the system components. A suitable system architecture was developed and finally the solution was installed in 300 apartments (30 apartments each at each of the ten pilot locations). One particular challenge in the development and testing of the ICE-WISH service are the structural and technical standards and infrastructures, which vary greatly between countries; the heterogeneous climate conditions, the strongly divergent usage behavior in the ten participating countries, and other cultural peculiarities.

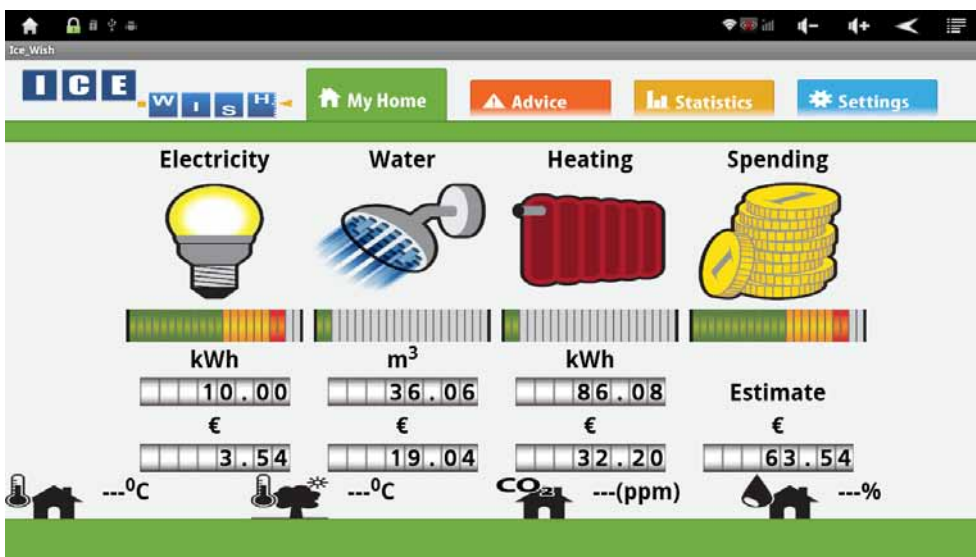

On the TV screen, residents can see at one glance their current usage, the costs for all relevant types of energy and water, as well as further information on indoor climate and outdoor temperature. Additional screens provide more detailed information and advice.

In addition to its collaboration in the elicitation and assessment of the requirements as well as the specification of the overall system, Fraunhofer IESE is primarily providing algorithms and services for the following functional areas in the context of this project:

- Analysis of the energy and water consumption in comparison to previous values, to similar apartments, or to the expected consumption
- Prediction of future consumption, also with consideration of climate conditions, changes in the appliances used in a household, or changes in the usage behaviors
- Analysis and prediction of the costs for energy and water based upon the usage and available rate information
- Visualization of the analysis results on the TV screen and on a web-based platform in a manner that is comprehensible to the target groups.

Collaboration Partner

19 partners from 10 European countries see Project Homepage www.ice-wish.eu

Further Reading:

Business Area Information Systems p. 52
 Division Process Management p. 65

INSIDERS TECHNOLOGIES: Joint Research & Development Lab

Contact

Dr. Marcus Trapp
Phone +49 631 6800-2186
Fax +49 631 6800-9 2186
marcus.trapp@iese.fraunhofer.de



Dr. Marcus Trapp

Nowadays, small and medium-sized enterprises, in particular, are increasingly facing the challenge of having to keep pace with the speed of globalizing markets. Against this background, the systematic use of methods, techniques, and tools for the development and evolution of software is becoming more and more important.

Support comes from a novel type of collaboration model, the Joint Research & Development Lab, which creates a bridge between future-oriented research and innovative software development. Here, the method competence of the researchers of Fraunhofer IESE joins the product competence of the software developers of a company. This is an advantage particularly for small and medium-sized enterprises, as they often shy away from the major investment necessary for establishing their own research and development department. The Joint Research & Development Lab offers a suitable alternative for this situation. In purpose-built lab rooms, project teams consisting of Fraunhofer IESE staff and employees of the collaborating software company develop new ideas, design the software architecture, and assess the quality of the software. In this context, the organization and modeling of the corresponding data structures plays an important role.

The goal of this collaboration is direct cooperation during the development of products that fulfill state-of-the-art standards. Combining the competencies of one partner with the supplementary knowledge of the other partner creates an innovative lead and safeguards competitiveness, on the national as well as on the international level.

Collaboration Partner

Insiders Technologies GmbH
www.insiders-technologies.de



During the first phase of the Joint Research & Development Lab, researchers from Fraunhofer IESE and software developers from Insiders Technologies are jointly engaged in further development of the product smart COCKPIT, which will be offered in a new release as part of the Digital Mailroom Suite of Insiders Technologies. smart COCKPIT is a product for the cross-system control and monitoring of all incoming document-related business processes. The contribution of Fraunhofer IESE to the product development process is its expertise in software and system development methods. An initial focus is currently on the areas of Usability & User Experience Engineering, Software Architecture, and Quality Assurance in the context of agile software development with Scrum.

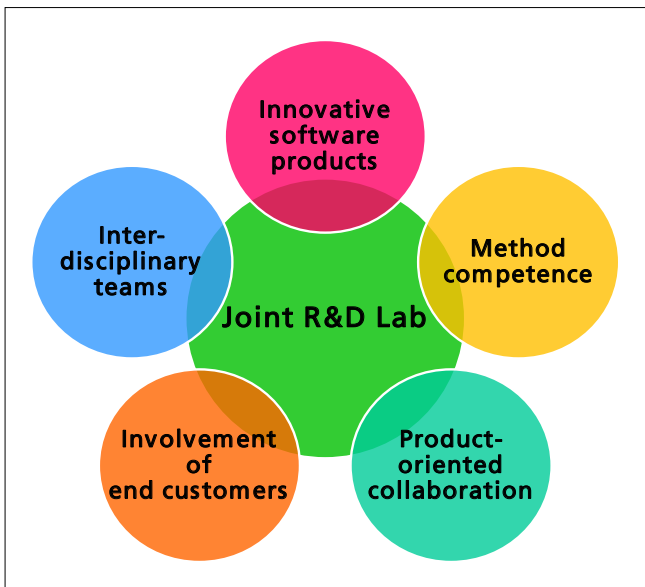

A look at the lab (upper left)

Werner Weiss and Prof. Dieter Rombach signing the collaboration agreement (upper right)

Design of the Joint Research & Development Lab at IESE (left)

In addition, cooperation in the Joint Research & Development Lab allows adding and using research competencies from the global Fraunhofer network. One of the special highlights of this collaboration is considered the direct involvement of future end customers such as large insurance companies, who can already exert influence on the product results before these have reached industrial market maturity.

“As a dynamic company, our goal is to continually improve the quality of our products and solutions through comprehensive know-how and intensive customer dialog. This is why we have always relied on dependable and trustworthy exchange with our customers and business partners. Our collaboration with the renowned Fraunhofer IESE supplements our excellent research network and ensures that the products of Insiders have the highest quality and will remain competitive in the future. We are very much looking forward to the synergy effects from the Joint Research & Development Lab.”

Werner Weiss, Managing Director, Insiders Technologies GmbH

Further Reading:

Business Area Information Systems

p. 52

Division Information Systems p. 69

JOHN DEERE: Secure Software Engineering for Embedded Systems

Contact

Christian Jung
Phone +49 631 6800-2146
Fax +49 631 6800-9 2146
christian.jung@iese.fraunhofer.de



Christian Jung

Collaboration Partner

John Deere
www.johndeere.com



Modern commercial vehicles are equipped with a non-trivial amount of software. This includes, for example, highly intelligent engine controls that consider the current work situation and put the emission exhaust in relation to the needed performance in order to allow environment-friendly work processes. Comfort functions are based on the intelligent interaction among several connected components within a vehicle in order to achieve the best possible results. Further areas to be mentioned in this context include the increase in vehicle-to-vehicle connectivity as well as vehicle-to-infrastructure, which are both becoming ever more important (e.g., in fleet management).

The communication features available today allow manufactures to offer their users numerous services for various types of usage, which enable, for instance, remote diagnosis and maintenance. In addition, properties and features of modern commercial vehicles can be realized via software, without the need for physical access to the system. Vehicles thus increasingly turn into interconnected systems, which can also attract the interest of hackers.

Overcoming protective measures in order to fraudulently acquire cost-incurring features and services may be a worthwhile aim. The overcoming of protective measures can even be systematically offered for sale by dubious providers, at the detriment of manufacturers and authorized service providers. Another coveted item may be sensitive data that might be exchanged between the vehicles and the infrastructure.

In the first step of a project with John Deere from the area of secure software development, Fraunhofer IESE has therefore determined potential risks for modern commercial vehicles by means of a comprehensive study. The results range from potential remote attacks from all over the world to direct physical access to internal controls. The lessons learned help the project partner understand current potential risks as well as such risks that can be predicted based on future developments, and serve as a basis for initiating suitable countermeasures.

As a complementary action, Fraunhofer IESE is supporting the project partner John Deere in the development of methods and tools for the secure development of software for embedded systems. In order to facilitate identification of suitable security measures for this development, Fraunhofer IESE has collected existing process and tools along the software development and has examined them in terms of their applicability for embedded systems. The experiences of Fraunhofer IESE in the area of secure software development for information systems were used to adapt the security engineering techniques established in that domain to the specificities of embedded system development. Customer-specific constraints, such as agile development



Threat Agent	Attacker (external, malicious entity)	Authorized Subject (non-hostile)	Trusted Subject (non-hostile)	Trusted Individual (internal entity)
Adversary Action	<ul style="list-style-type: none"> Access (Unauthorized) Denial of Service Information Disclosure Malware Installation Modification of Data Privilege Escalation Service Disruption System Hijacking System Shutdown System Tampering System Unavailability System Upgrade System Vulnerability System Weakness System Zeroization 	<ul style="list-style-type: none"> Access (Unauthorized) Denial of Service Information Disclosure Malware Installation Modification of Data Privilege Escalation Service Disruption System Hijacking System Shutdown System Tampering System Unavailability System Upgrade System Vulnerability System Weakness System Zeroization 	<ul style="list-style-type: none"> Access (Unauthorized) Denial of Service Information Disclosure Malware Installation Modification of Data Privilege Escalation Service Disruption System Hijacking System Shutdown System Tampering System Unavailability System Upgrade System Vulnerability System Weakness System Zeroization 	<ul style="list-style-type: none"> Access (Unauthorized) Denial of Service Information Disclosure Malware Installation Modification of Data Privilege Escalation Service Disruption System Hijacking System Shutdown System Tampering System Unavailability System Upgrade System Vulnerability System Weakness System Zeroization

Security-focused story	Backlog task(s)	SAFECODE Fundamental Practice(s)	CWE-ID
As A/D , I want to ensure and as T , I want to verify allocation of resources within limits or throttling	<ul style="list-style-type: none"> [A/D] Define limits on resource allocation. [T] Conduct performance/stress testing to ensure that the numbers chosen are realistic (i.e., backed by data) [A/D/T] Define and test system behavior for correctness when limits are exceeded. Examples: <ul style="list-style-type: none"> Preventing users from uploading files greater than a specific size, e.g., 2MB [...] 	<ul style="list-style-type: none"> Validate Input and Output to Mitigate Common Vulnerabilities Perform Fuzz/Robustness Testing 	CWE-770
As A/D , I want to ensure and as T , I want to verify application of or access within index boundaries of buffers and arrays	<ul style="list-style-type: none"> [A/D] Define where buffer operations (on dynamic buffers) occur. Define data types and bounds for buffer operations. [D] Scan source code for such violations using static code analyzer tools, e.g., Coverity. [A/D] Conduct false positive analysis of flagged issues. 	<ul style="list-style-type: none"> Minimize Use of Unsafe String and Buffer Functions Use a Current Compiler Toolset 	CWE-120 CWE-131 CWE-805

Typical development artifacts and possible secure software engineering activities

methods, had to be taken into account. Particularly the area of embedded systems places new challenges on secure software engineering, since special constraints and conditions must be taken into account. In particular, requirements regarding real time, reliability, functional safety, and hardware limitations have a major impact on the degree of freedom in choosing and using quality assurance measures for security. Furthermore, the effects of security measures on other quality attributes must also be taken into consideration. This is an area where a lot of research is still needed.

In the first step, all methods and practices from the early software development phases were checked with regard to their applicability in the special context of embedded systems for commercial vehicles, as fundamental decisions must be made here. One major requirement is threat modeling, which has proven to be extremely successful in the information systems domain. The benefit of various techniques used during the realization and testing phase was also investigated. Programming standards, static and dynamic source code analyses, or special testing procedures such as Fuzz Tests are promising approaches for improving the security of embedded systems in the long term.

Further Reading:

- Business Area Automotive and Transportation Systems p. 46
- Division Information Systems p. 69

proALPHA: Test Process Improvement with Metrics

Contact

Dr. Frank Elberzhager
 Phone +49 631 6800-2248
 Fax +49 631 6800-9 2248
frank.elberzhager@iese.fraunhofer.de



Dr. Frank Elberzhager

Collaboration Partner

proALPHA Software AG
www.proalpha.de



The increasing complexity, size, and flexibility of modern software constitute a major challenge for quality assurance, in particular when there are high demands on quality. However, comprehensive testing, which would be desirable, is often not possible due to the sheer size of the software and limited resources. In order to still be able to guarantee a satisfactory level of quality, quality assurance has to be performed in a focused manner.

This focusing of the test process was the aim of proALPHA Software AG in a joint project with Fraunhofer IESE. proALPHA Software AG is one of the leading manufacturers of ERP systems. These systems offer a multitude of masks, which are used in various ways depending on the customer. The result is that these systems are used in many different process variants. Since these processes are not known in their variability at development time, a systematic test of all processes used is impossible – and a test of all potentially used processes is precluded from the outset due to the huge number of possible combinations. This, however, creates the risk that defects only appear after the customer has purchased the product – with the corresponding negative effects.

The goal of the project was therefore to systematically focus on the limited test resources in order to find as many defects as possible and especially to find severe defects as early as possible. For this endeavor, historical data were already available for evaluation. During the course of the project it turned out that an iterative procedure is most suitable for analysis and optimization. This procedure mainly consists of four items, which were performed iteratively.

- Determination of improvement goals and definition of context-specific metrics
- Performance of data collection
- Analysis of the results and joint interpretation
- Derivation of improvement measures

The improvement goals and the metrics for measuring the achievement of these goals were elicited in a joint workshop. Here, it was particularly important to measure at which point of time defects were detected in the various releases. In total, 15 metrics were defined, some of which turned out to be unusable. On the other hand, other metrics were only added as the project progressed.

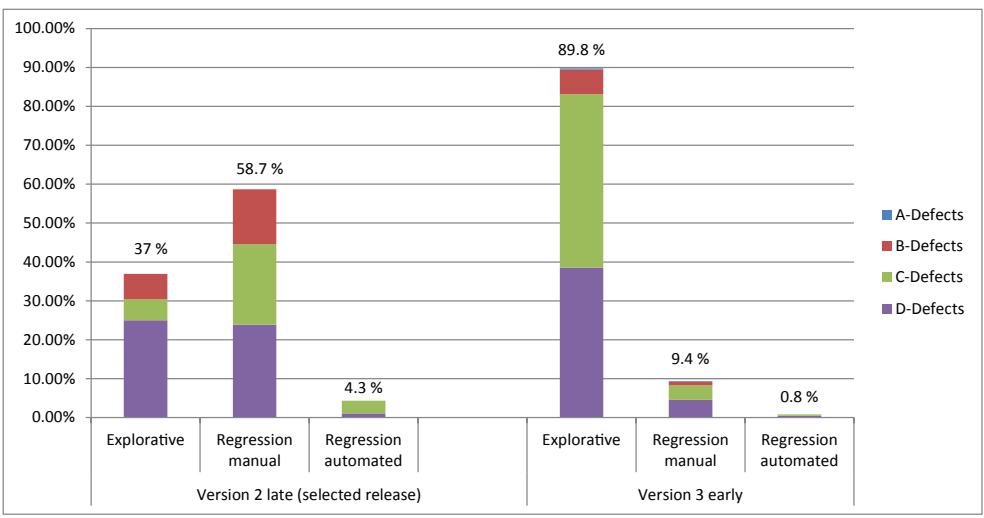

Proportion in percentage of the defects found with various types of tests (explorative testing and different types of regression tests) in two different versions (still classified according to defect severity). It can be observed that the majority of all defects were found via explorative tests.

Thanks to a large collection of historical data, which had been gathered at proALPHA Software AG for several years already, data were available very quickly. The analyses will allow collecting additional new data in the future.

The data were packaged in order to use them for calculating different metrics. These metrics were then discussed and interpreted in joint workshops, which required both the professional expertise of Fraunhofer IESE and the domain knowledge of proALPHA Software AG. One of the results was that a high frequency of change was correlated with the number of defects.

In the last step, improvement measures were discussed and determined. One of the conclusions was that critical modules must be systematically subjected to intensive explorative tests. In 2013, further analyses are planned to check the improvement measures already introduced and to further optimize the test.

Further Reading:

Business Area Information System

p. 52

Division Process Management p. 65

Division Information Systems p. 69

IBIS: Designing Intuitive Use with Image Schemata

Contact

Sebastian Weber
Phone +49 631 6800-2116
Fax +49 631 6800-9 2116
sebastian.weber@iese.fraunhofer.



Sebastian Weber

Further Information

Project Homepage
www.ibis-projekt.de



FUNDED BY



Bundesministerium
für Bildung
und Forschung

Grant no. 01IS11017

On the software market, small and medium-size enterprises (SMEs) are facing powerful competitors that act globally and generally have their own research departments. In order to be able to hold their ground against this competition in the long term, it is absolutely crucial for SMEs to develop unique product selling points and product innovations.

However, SMEs are frequently unable to maintain a larger staff of specialized employees for User Research, User Experience Design, etc. Only a handful of staff are therefore often available for taking care of product usability.

In addition, the methods used to date often do not permit a strict transition from requirements analysis to UI design, which is known as the “design gap”. It thus strongly depends on the experience and the skills of the developers how good the results are and whether the resulting products correspond to the mental models of future users.

The goal of the research project IBIS was to bring a method to application that is easy to integrate and supports SMEs in developing innovative and creative products whose use is intuitive – even if they have little design expertise.

The core of the IBIS method developed in the context of this project is the so-called “Image Schemata” (IS) method, which was developed at Technische Universität Berlin and at the University of Cambridge. IS are abstract knowledge representations in human memory, which every human creates in everyday life through recurring sensory experiences with his environment. The basic idea of the IS method is to use these everyday experiences and to incorporate them into concrete product and design requirements.

The task of Fraunhofer IESE was to make the IS method applicable for software-producing SMEs. For this purpose, the IS method was first embedded into a well-proven requirements and usability engineering process developed at Fraunhofer IESE (SATISFY). This process was then adapted to the existing software development processes of the participating SMEs. In addition, Fraunhofer IESE played a major role in defining suitable evaluation methods for measuring the success of the IBIS method.

In the context of the research project, the IBIS method was applied by two SME partners in a real development project and continually evaluated. It could be demonstrated that it is easy to

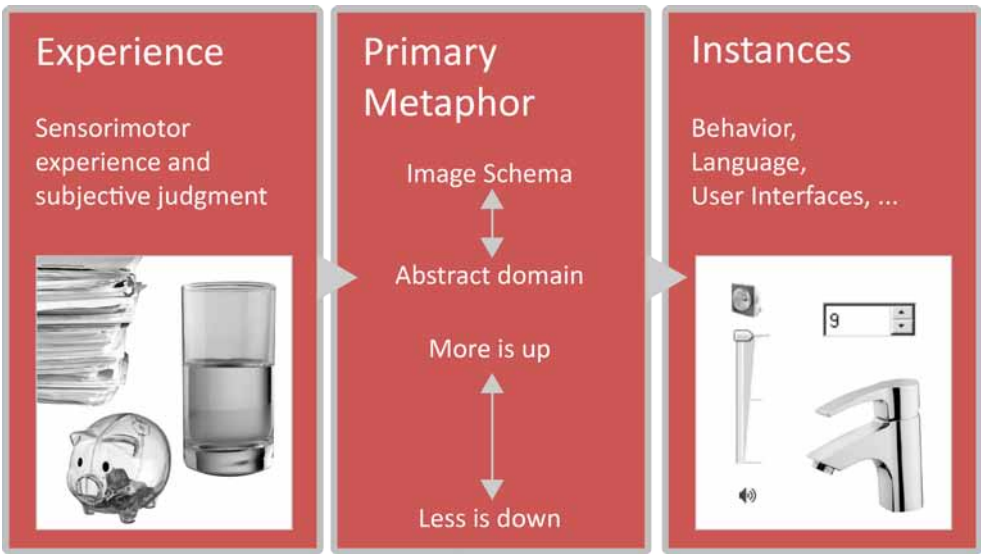
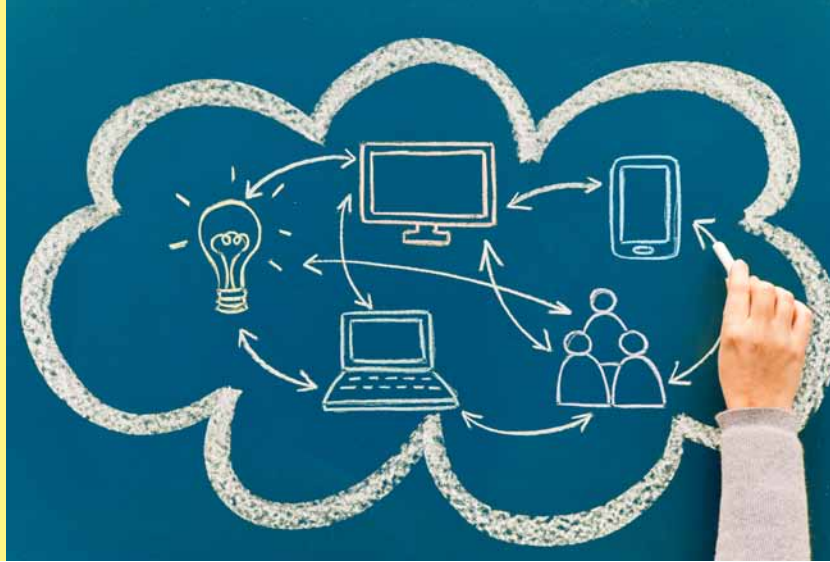
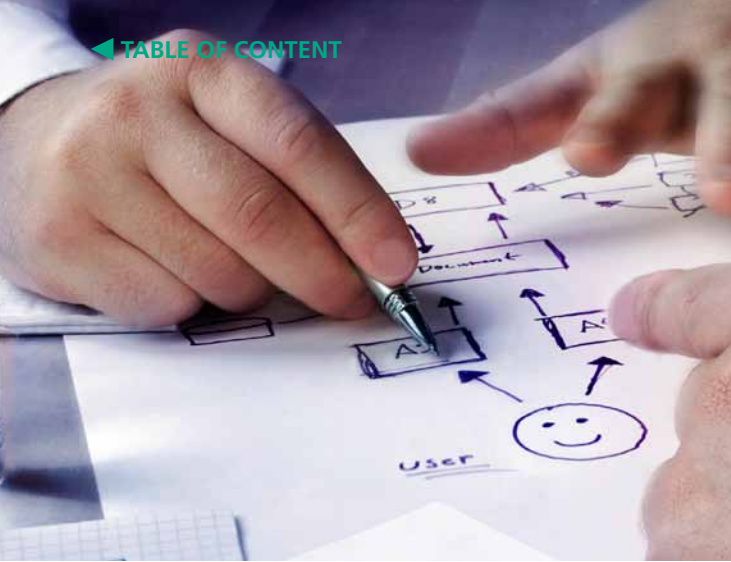

Use of everyday experiences in design decisions

integrate into the software development processes of SMEs, without replacing these or modifying them too much, and that it can also make the entire product development more efficient. Products developed with the IBIS method showed more positive values compared to products developed without the use of the IBIS method in terms of the success criteria time, mental effort, and preference. Hence, it is the first method that integrates the IS successfully evaluated to date into a requirements resp. design process in a systematic, engineering-style way, and thus allows them to be used by SMEs as well.

"I am impressed; this is a collection of valuable material." (Wolfgang Milszus, DLR)

"Thanks to IBIS we are now able to offer software whose use is intuitive. The products are demonstrably accepted better by the users. This will ensure our competitiveness in the future." (Karin Fetzer, ICT)

"The result has absolutely convinced me. Everything looks really nice and works very well." (Bruno Zimmer, Ölmühle brunozimmer, end customer)

Collaboration Partner

a3 systems GmbH
www.a3systems.com

ICT Solutions AG
www.ict.ag

Technische Universität Berlin
www.mms.tu-berlin.de

Further Reading:

Business Area Information Systems p. 52
 Division Information Systems p. 69

SOFTWARE-CLUSTER: The Next Generation of Enterprise Software

Contact

Dr. Christian Webel
Phone +49 631 6800-2185
Fax +49 631 6800-9 2185
christian.webel@iese.fraunhofer.de



Dr. Christian Webel

Further Information

Project Homepage
www.software-cluster.org



FUNDED BY



Bundesministerium
für Bildung
und Forschung

The Software-Cluster is entering the second round. The region around the software cities Kaiserslautern, Darmstadt, Karlsruhe, Saarbrücken, and Walldorf, which was a winner in the German government's leading-edge cluster competition, has successfully passed intermediate evaluation by an international jury. This means that the partners can now continue the projects they launched to create the basis for the enterprise software of the future, and they can permanently establish the German Software-Cluster in the international top group. The positive evaluation was not least due to the first-rate results from the joint projects Emergent and SWINNG.

In the project "Emergent", which is about studying and developing the foundations of the next generation of enterprise software under the leadership of Fraunhofer IESE, we did, for example, develop the Engineering Software App, a digital method handbook for the iPad. The first example realized was a method for designing mobile business applications (mConcAppt). mConcAppt describes an approach for the requirements elicitation as well as for the UI and the interaction design of mobile business applications, which can be very easily integrated into existing development processes. The app shows and explains the individual steps of the method with the help of text samples, templates, images, and videos. During the development of the app, a lot of attention was paid to providing high User Experience in order to allow even people who are not software engineering experts to get quick and simple access to this admittedly quite complex subject. The app is thus equally suitable for both novices and experts. The second method we integrated was a requirements elicitation method for the development of intuitive user interfaces from the IBIS project (see page 98 of this Annual Report).

In the context of the second Cluster project, "SWINNG", the focus is on the design of suitable development processes for the enterprise software of the future as well as the so-called Cluster governance, i.e., the optimization of the internal processes of the Cluster as well as the dissemination of the developed innovations throughout the Cluster region and beyond. Here, one of the central tasks of Fraunhofer IESE is the evaluation of the Cluster as such as well as of the developed concepts and solutions. This included examining the connections among the Cluster partners as well as determining the qualification needs of professional staff. In this context, a survey was performed among SMEs in Rhineland-Palatinate in order to capture the views of practitioners regarding the need for emergent software. To ensure the continuous evolution of the Cluster, another task is to elicit the critical processes within the Cluster itself and to optimize them. These include, for instance, processes regarding international communication and public relations, technology transfer, and support for start-up entrepreneurs from within the Cluster.

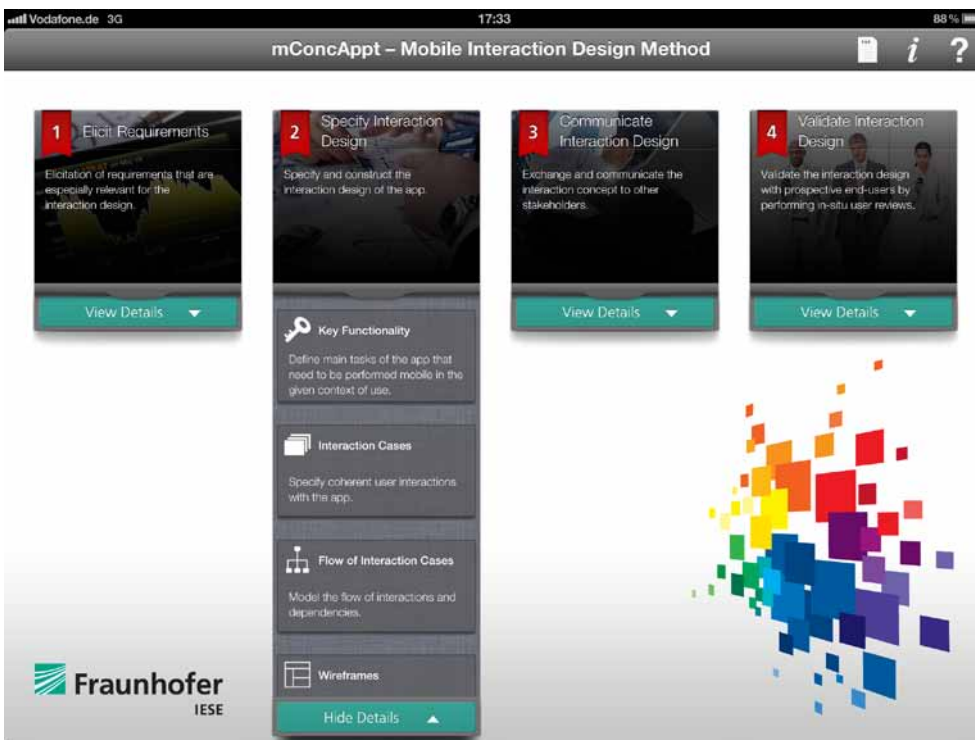

mConcAppt – a method for the interaction design of business applications as part of the Engineering Software App

<https://itunes.apple.com/de/app/engineering-software/id555966291>

In the spring of 2013, the third project in the Cluster that involves participation by Fraunhofer IESE will be the project "Software Innovations for the Digital Enterprise" (SINNODIUM). SINNODIUM will bring together the results from the previous Cluster projects and evolve them further. SINNODIUM will pay particular attention to mobile end devices, which are becoming ever more popular in the business context as well. The focus will be mainly on concepts for user interfaces and security aspects regarding the use of such devices in a business environment. In the project SINNODIUM, Fraunhofer IESE will continue its work in the areas of interoperability, IT security, and Cluster governance.

As a special highlight of the year 2012, the Fraunhofer IESE researchers Christian Jung, Balthasar Weitzel, and Dominik Rost were admitted to the Software Campus. The Software Campus targets only excellent Master and PhD students and is aimed at training the IT managers of tomorrow. To this end, the campus combines state-of-the-art research in innovative IT research projects and management training offered by the industry partners of the Software Campus. The Software Campus is funded by the German Federal Ministry of Education and Research (BMBF).

The joint projects within the Software-Cluster are funded by the German Federal Ministry of Education and Research (BMBF) in the context of the Hightech Strategy under grant numbers 01IC10S01A (EMERGENT) and 01IC10S051 (SWINNG).

Further Reading:

- Business Area Information Systems p. 52
- Division Process Management p. 65
- Division Information Systems p. 69

Innovation Center Applied System Modeling: “Smart Farming” Living Lab

Contact

Dr. Jens Knodel
Phone +49 631 6800-2168
Fax +49 631 6800-9 2168
jens.knodel@iese.fraunhofer.de



Dr. Jens Knodel

Further Information

Project Homepage
www.applied-system-modeling.de



Due to the increasing global population and the scarcity of land and fossile resources, agricultural technology is facing ever greater challenges. In order to master these challenges successfully, higher productivity and increased efficiency are indispensable in agricultural technology. Nowadays, innovations are achieved primarily through advances in the area of mechanization, automation, and fertilization. In addition, software plays an increasingly important role in agricultural machinery, implements, and sensors.

Increasing interconnectedness all the way to a Smart Ecosystem is emerging as a megatrend in this domain: Objects of the real world are represented by their digital counterparts and are interconnected with each other. Smart Ecosystems realize processes across systems, which incorporate not only sensors, but also embedded systems, information systems, and mobile end devices. The business processes and technical processes of the single systems are optimized globally from the perspective of the ecosystem.

In its “Smart Farming” Living Lab, Fraunhofer IESE is demonstrating how the core competence of software engineering works and meets the challenges of the domain. In the Living Lab, concepts and technologies can be efficiently tested virtually or as prototypes before they are further developed into a real system by the industry partner. In the “Smart Farming” Living Lab, companies can use an existing lab infrastructure and system prototypes. In addition, an agricultural diorama on the scale of 1:32 is available with appropriate model vehicles. The diorama serves both the purpose of simplifying demonstrations (e.g., at events or trade fairs) and of providing software engineering visualization of concepts, and allows testing and evaluating alternatives.

The things that Fraunhofer IESE is demonstrating in its “Smart Farming” Living Lab include software engineering solutions for the following challenges faced by systems in the agricultural domain:

- **Security across system boundaries:** How to protect data that are transferred from one system to another system even after they have left one’s own system?

This project is being funded by the Fraunhofer-Gesellschaft and by the State of Rhineland-Palatinate.

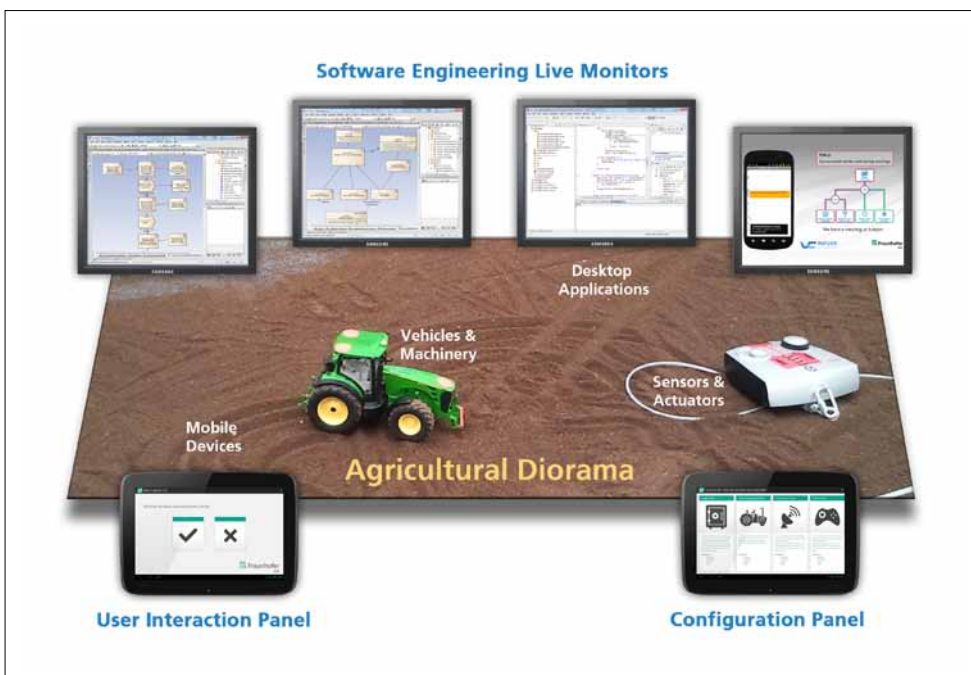

Smart Farming: Interaction of single systems in a Software Eco-system – illustrated with an agricultural diorama, scale 1:32.

- **Open architectures:** How to design future systems in such a way that they will enable interaction with third-party systems that are unknown at development time? How to realize protective measures to avoid third-party systems from compromising one's own system?
- **Modular safety cases:** How to ensure functional safety between a random combination of tractors and one or several implements?
- **Incorporation of mobile end devices:** How to use modern end devices (smartphones, tablets, etc.) in combination with existing systems to achieve an optimal user experience for the user?

In summary: **Software makes agricultural technology smart**, and Fraunhofer IESE ensures quality and efficiency in software development. Software Engineering methods are the key to successfully developing software systems despite their high level of complexity.



Further Reading:

Business Area Automotive and Transportation Systems	p. 46
Business Area Information Systems	p. 52
Division Embedded Systems	p. 61
Division Process Management	p. 65
Division Information Systems	p. 69
Project John Deere TIA	p. 76

FRAUNHOFER ACADEMY: Software Architecture Seminars – Expert Knowledge from the Source

Contact

Dr. Thorsten Keuler
Phone +49 631 6800-2162.
Fax +49 631 6800-9-2162
thorsten.keuler@iese.fraunhofer.de

Dr. Jens Knodel
Phone +49 631 6800-2168
Fax +49 631 6800-9-2168
jens.knodel@iese.fraunhofer.de

Dr. Matthias Naab
Phone +49 631 6800-2249.
Fax +49 631 6800-9-2249
matthias.naab@iese.fraunhofer.de

Further Information

Competence Page
architecture.iese.fraunhofer.de



Modern software systems are so complex that development organizations need abstractions in order to make decisions about the implementation of new features, necessary adaptations due to quality requirements, the use of other technologies, and the planning of migration projects. Such decisions can be supported by the architecture of a software system, provided it is documented explicitly.

With over 50 projects and a total of more than 25 person-years of project experience, the lecturers of Fraunhofer IESE have packaged their approach ACES (Architecture-Centric Engineering Solutions) in the seminar "Software Architecture". Experiences from practice together with the basics from applied research make this seminar an interesting event for architects with practical experience and those aspiring to be such. In this seminar, the participants get to know the tools used by successful software architects and benefit from the extensive experience of the lecturers. In accordance with the philosophy of Fraunhofer, the seminar is characterized by a large degree of practical relevance, interactivity, and numerous exercises in which the participants can apply in practice what they have learned.

Fraunhofer IESE offers this seminar at the Fraunhofer Center in Kaiserslautern twice a year (in April and in October). In these seminars, the participants come from various domains. In addition to the skills they learn at the seminar, they also regard the interaction among themselves as a positive aspect. Fraunhofer IESE also offers custom-tailored in-house seminars, i.e., the lecturers teach the seminar on site at the customer's location. In these cases, the contents can be assembled individually for the respective customer, and cases from its daily business can be discussed in the practical exercises.

In the year 2012, more than 50 participants attended the two seminars on "Software Architecture". All of the participants were very satisfied with the seminar, the packaging of the contents, and the learning atmosphere.

In 2013, these seminars will continue to be offered on a regular basis and the lecturers will be available for in-house seminars. As they did in 2012, the lecturers will always incorporate current issues and trends. In 2012, the main topic was the role of architecture in agile development, which has become a permanent part of the seminar in the meantime.

The lecturers Thorsten Keuler, Jens Knodel, and Matthias Naab are looking forward to further interesting seminars with many participants eager to take part in discussions.

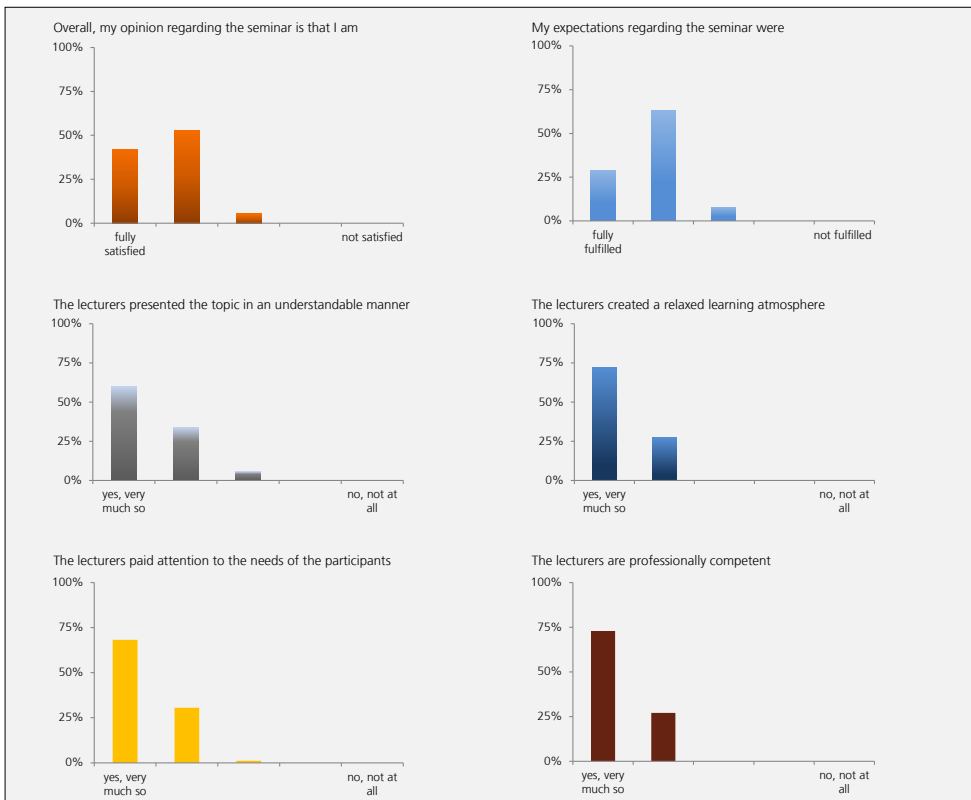

Top: Practical exercises at the Academy seminar; participants and lecturers of the Academy seminars in 2012

Left: Feedback from the seminar participants

Participants' comments on the seminar "Software Architecture" at IESE:

- "At the seminar, a comprehensive proposal was made regarding how to design the role of the architect."
- "Well organized, very helpful. Thank you!"
- "Summarized the complex topic of SW architecture in a reasonable manner, thus creating a good basis on which to build in the future."
- "A comprehensive overview of the subject area with practical in-depth information/applications; good exchange with colleagues from other companies."
- "Enriching"

Dr. Niels Streekmann, BTC Business Technology Consulting AG, about the in-house seminar: "The Fraunhofer IESE staff demonstrated in the in-house architecture seminar performed at BTC AG that they are capable of successfully combining extensive theoretical knowledge with practical competence. The seminar took place in a very constructive and pleasant atmosphere. They taught the basics of software architecture with the help of practical examples and showed ways of using the contents in everyday work. The lecturers showed a lot of enthusiasm in dealing with specific requirements."

Collaboration Partner

Fraunhofer Academy
www.academy.fraunhofer.de



Further Reading:

- Division Embedded Systems p. 61
- Division Information Systems p. 69



INTERNATIONAL ACTIVITIES

Fraunhofer IESE has a very strong international orientation. This is not only reflected in the fact that IESE currently employs staff from twelve different nations and that the language of the institute is English, but can also be seen in the growing number of international projects.

Fraunhofer IESE has established subsidiaries in the strategically important countries USA, Australia, and Brazil (so-called Centers resp. Project Centers):

- Fraunhofer Center for Experimental Software Engineering (CESE) at the University of Maryland, College Park, MD, USA (since 1998)
- Fraunhofer Project Center on Transport & Logistics at NICTA, Sydney, Australia (since 2010)
- Fraunhofer Project Center for Software and Systems Engineering in Salvador, Bahia, Brazil (since 2012)

From the perspective of Fraunhofer IESE, these subsidiaries pay off for various reasons: additional competencies that we can in turn offer to our customers in Germany and in Europe; additional third-party industry project funds; and the acquisition of highly qualified staff. Examples of additional competencies are the development of the reverse engineering tool SAVE or the business alignment method GQM+Strategies®. An example of industry projects is the collaboration project with Campina Grande, Brazil, on the topic of medical devices. Personnel acquisition is currently most promising via our contacts in Brazil.

In the following, we present our subsidiaries and describe some selected international projects:

Fraunhofer Center for Experimental Software Engineering, Maryland (CESE)	108
Fraunhofer Project Center for Transport and Logistics in Australia	114
Fraunhofer Project Center for Software and Systems Engineering in Brazil	116
ECOPETROL: Software Quality Modeling in the Oil and Gas Domain	118
JAXA: Evaluating the Quality of Safety-Critical Software Systems	120

Fraunhofer Center for Experimental Software Engineering CESE, Maryland

Director: Prof. Dr. Rance Cleaveland

The Fraunhofer Center for Experimental Software Engineering CESE, Maryland is located in College Park, Maryland and conducts applied research in software engineering processes and technologies. It collaborates with private-sector organizations, government agencies, and academic and research institutions to develop innovative, practical approaches to software development and management issues.

CESE has affiliations with the University of Maryland at College Park and the Fraunhofer Institute for Experimental Software Engineering (IESE) in Kaiserslautern, Germany.

The Center's project portfolio includes a mixture of research efforts into new software technologies and empirical evaluations of existing tools and processes, and service-provision contracts to assist clients with software development and acquisition needs. Customers include government agencies such as the Department of Defense, the US Food and Drug Administration and NASA, and large multi-national companies such as Boeing and Robert Bosch. CESE also supports small and medium-sized companies with software needs in the Washington, D.C. – Baltimore, Maryland corridor.

Competencies

- Measurement and Knowledge Management
Contact: Dr. Forrest Shull
- Software Management and Process Improvement
Contact: Ms. Kathleen Dangle
- Software Architecture and Embedded Software
Contact: Dr. Mikael Lindvall
- Software Verification and Validation
Contact: Prof. Rance Cleaveland

Business Areas

- Aerospace / Defense
Contact: Kathleen Dangle, Frank Herman
- Automotive
Contact: Prof. Rance Cleaveland
- Medical
Contact: Dr. Mikael Lindvall

University Partners

- University of Maryland at College Park
- University of Maryland at Baltimore County
- Stevens Institute of Technology
- University of Kaiserslautern

Other Partners

- Axiom Resource Management, Inc.
- Johns Hopkins University Applied Physics Laboratory
- NASA IV&V Center





PROJECTS IN PROGRESS

NASA Space Network Ground Segment Sustainment

CESE is working with NASA on a major overhaul of NASA's space-network communications system.

The NASA Space Network (SN) is a communication signal relay system that provides tracking and data-transfer services between user platforms and user Mission Operations Centers (MOCs). The SN was established in the early 1980s to replace NASA's worldwide network of ground tracking stations and consists of a constellation of data relay and tracking satellites and associated ground systems. This space-based relay system can provide essentially unlimited communication services for altitudes ranging from 73 km to 9000 km, a capability that is unique within the civilian and commercial space industry. In addition, limited communication services can also be provided for customer platforms located on the ground and ocean/ sea surfaces (e.g., ships) as well as airborne platforms (e.g., atmospheric balloons). The fleet of Tracking and Data Relay Satellites (TDRS) in geosynchronous orbit serves as a data relay system between SN ground system and user platforms.

The SGSS project replaces a majority of the existing SN Ground Segment with modern technology in order to fulfill the following objectives:

- 1) Monitor and control the SN Flight and Ground Segments; including management of the configuration, health and safety of the TDRS spacecraft fleet and SN Ground Segment elements.

- 2) Provide SN user service planning and scheduling.
- 3) Relay user signals in forward and return directions between the ground and user platforms.
- 4) Distribute user data on the ground using NASA Integrated Services Network (NISN) services, user-provided networks, and local interfaces (LIs).
- 5) Provide tracking services for TDRS and user spacecraft.

The heart of CESE's 2011 and 2012 SGSS research was the collection and analysis of software progress and quality metrics from the SGSS development contractors. Software progress metrics include measures such as requirements decomposed, requirements volatility, components designed, coded, and tested, etc. Software quality measures include defects found, defects corrected, etc. The analysis of these metrics permits CESE to identify areas of risk and opportunities for improvement of contractor outputs delivered to NASA. CESE also uses the metrics analysis to research new technologies and to infuse those that demonstrate risk reduction, better cost/schedule adherence, or software technology improvement into both the NASA Project Team and the SGSS development contractors. Specific technologies that CESE is researching include software cost and schedule estimation and tracking, software defect detection and Reliability Growth Models, Service Oriented Architectures (SOA), and software metrics presentation techniques.

In 2012, CESE played key roles in various critical design reviews for the SGSS project, and was also instrumental in using its metrics-based performance research to provide feedback and insight to NASA staffers on the performance of the main software subcontractor.

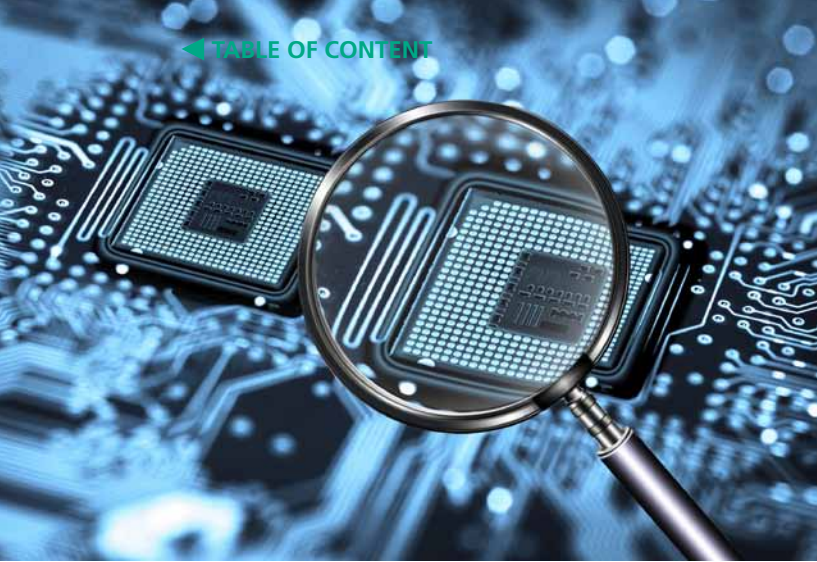

The Fraunhofer Approach for Software Testing (FAST)

In 2012, Fraunhofer CESE received additional special funding from Fraunhofer USA to support the ongoing development of the Fraunhofer Approach for Software Testing (FAST). FAST is now a method for testing software from many domains, including aerospace, medical device, and web software. Highlights during the year include the following:

- 1) CESE further developed technical collateral, including a model-based software testing architecture, a “design for testability” knowledge base, reusable testing models, and a testing process and best practices. These assets constitute the main intellectual property for Fraunhofer and are already being used in several third-party projects.
- 2) Center researchers continued to uncover previously unknown critical issues in NASA communications systems and to develop further improvements of the FAST. These testing projects were documented and used as tutorials and presentations that have been used to demonstrate the capabilities to interested parties.
- 3) Center staff also continued to use the FAST to test several commercial software systems, resulting in different types of detected software errors. Using the FAST, software may be improved for testability and then systematically tested because of the structured approach to software testing it facilitates.

The FAST is based on two fundamental technical principles. The first is Design for Testability: Based on extensive experience in working on large-scale software systems, CESE staff members have collected an informal corpus of knowledge encompassing principles that are used by the best software engineers at NASA and JHU/APL to enhance the ease of testing software. These best practices dramatically improve the testability of the final product.

The second technical foundation for the FAST is Model-based Testing (MBT). MBT is a new technology developed in the research community that has attracted attention among practitioners. In MBT, tests are specified as abstract, programming-language-independent models. A translator maps abstract test specifications to concrete tests. The advantages of this approach are as follows:

- 1) Such test models are insulated from changes in the source code, thus radically reducing maintenance costs.
- 2) One creates a test specification only once in terms of a model and executable test cases are automatically generated without programmer intervention.
- 3) Models are much easier to understand than code for humans and allow all stakeholders to understand how the SUT is being tested.
- 4) Tests automatically generated from behavioral models cover aspects of system behavior in a much more complete manner compared to manually written tests.



GQM+Strategies®

Scientists from Fraunhofer CESE and IESE have continued applying the GQM+Strategies® methodology, which was jointly developed by the two organizations to provide a framework for connecting business-level goals with software-project-specific technical metrics and management artifacts. The main project partner has been ECOPETROL, a Colombian oil company.

Fraunhofer CESE continues to collaborate with Fraunhofer IESE to refine the GQM+Strategies® methodology and to package the technology so that it can be used to improve staff efficiency in the measurement-related project work that is a core capability for both CESE and IESE. The collaboration continues to build a unique and marketable Fraunhofer capability, which will address one of the organizations' business areas and facilitate projects at both CESE and IESE. Both CESE and IESE have developed a set of assets that are reusable for both centers, including: a training course for use with customers and collaborators, a process description, a tool for visualizing the GQM+Strategies® outputs, and case studies – all of which stem from the knowledge, experience, and expertise resulting from the various engagements between CESE and IESE with customers.

Medical-Device Software Security

CESE has been developing a technical competence in cyber-security; as part of this effort, CESE staff members have been focusing on issues related to the security of embedded software in medical devices, such as insulin pumps, which are software-controlled and also possess capabilities for network connections. Such devices have been subject to highly publicized hacker attacks, which have attracted the attention of regulatory agencies in the US in particular.

As part of this research effort, CESE has developed an instrument for assessing the security vulnerabilities such devices may have. The tool builds on the hazard analysis that medical devices are typically subject to as part of their regulatory approval; specifically, it combines information about hazards with information about system interfaces to focus engineering attention on the different ways that hazards may be triggered through interfaces. Using this instrument, CESE has conducted security analyses of two insulin pumps and an implantable infusion pump made by subsidiaries of a major multinational medical-device company, and it has been in discussions with technical staff at the U.S. Food and Drug Administration on approaches for incorporating security considerations into the approval of medical devices prior to their release into the marketplace.



OSIRIS: Open-Source Information Retrieval and Analysis

As another part of its cyber-security effort, CESE has been working with a U.S. federal law-enforcement agency, the Baltimore/Washington High-Intensity Drug Trafficking Area (HIDTA), to develop a tool for collecting information from social-media websites on potential illegal-drug traffickers. Traditionally, agencies like HIDTA have relied on monitoring traditional communication media (telephones, conversations) of these targets, who in consequence have shifted platforms for communicating with their peers to social media such as Facebook® and Twitter®. To assist HIDTA’s law enforcement, CESE researchers have developed OSIRIS, a software tool that, given a target name and other optional associated information (e.g., date of birth, address, etc.), automatically constructs a “social media footprint” of that target from open-source Internet data (i.e., data the target has voluntarily revealed). OSIRIS then combines this social media footprint with records extracted from public information sources such as judiciary websites and real-estate databases to generate a target intelligence dossier. It also provides facilities for dynamically monitoring a target’s social media profiles so that intelligence analysts can be continually updated when the target’s “social media footprint” changes. The output from OSIRIS is used to understand the target’s background, associations, whereabouts, and the like.

The first prototype of OSIRIS (v1) was constructed in 2012 in collaboration with HIDTA and presented to HIDTA senior management as well as its governing board. Future plans for the work include adding to the technical capabilities of the tool and also developing projects with other law-enforcement agencies about the improvement and use of the tool. CESE is also in discussions with a company about licensing OSIRIS.

InViz: Real-Time Visualization of Cyber-Security Attacks

Also in the cyber-security realm, CESE has continued to develop its InViz (Instant Visualization) tool, which enables network administrators and other technical staff to visualize cyber-attacks on network infrastructure as they are occurring. InViz gives human experts as well as novices the capability to identify cyber-security attacks by means of novel information visualization techniques. The tool allows users to observe network traffic in real-time. The focus of CESE’s ongoing research is on understanding how to effectively present information to enable efficient identification of attack patterns in the large amounts of data typically produced by today’s network devices.

The current prototype tool is proving to allow quick detection of different attack patterns, such as denial-of-service attacks (an attempt to make the target computer unresponsive), backdoor exploits (an attempt to use known security leaks in installed server software), and vulnerability scanners (an attempt to identify specific weaknesses of network devices and servers, such as open ports).



CESE in Figures

CESE experienced significant growth in its revenues in 2012 vis à vis 2011. In part this was due to the slight dip in the Center’s performance in 2011 because of turmoil in the U.S. federal budget. The relative stability of the U.S. government’s finances in 2012 permitted agencies to reinvest in their missions, and this led to significant growth in CESE’s project revenues. As of the writing of this report, the final 2012 financial numbers were not available, but based on projections used by the Center, third-party revenues for 2012 should be approximately 15% larger than those for 2011. CESE is budgeting a 10% increase for 2013 over 2012 in these figures.

Important new project wins in 2012 included various efforts in the medical-device sector, both industrial and governmental; research projects through NASA’s Software Assurance Research Program; and new research efforts in cyber-security for medical-device and law-enforcement applications.

Total revenues (in T US dollars).

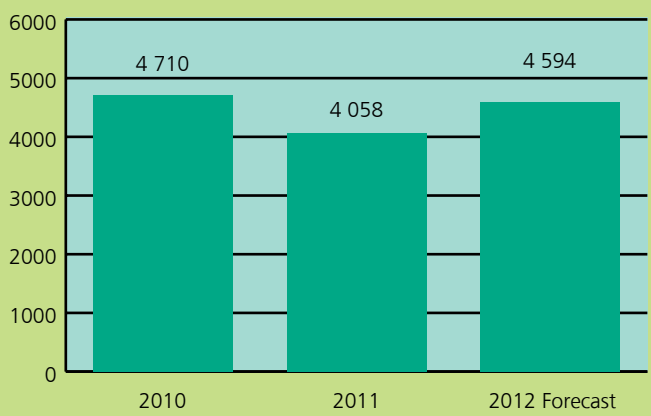

Third-party revenues (in T US dollars).

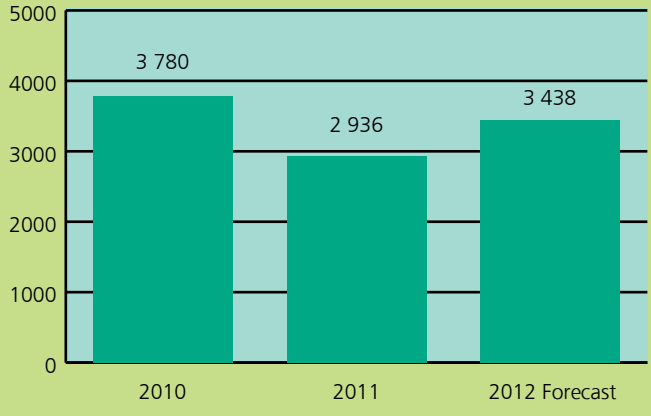

Retained earnings (in T US dollars).

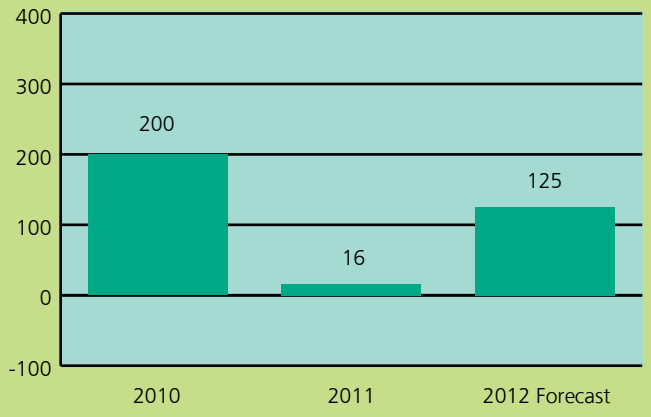

Fraunhofer Project Center for Transport and Logistics in Australia

Director: Dr. Glenn Geers, NICTA

Deputy Director: Dr. Christian Webel, Fraunhofer IESE

Contact

Dr. Christian Webel
Phone +49 631 6800-2185
Fax +49 631 6800-9 2185
christian.webel@iese.fraunhofer.de



Dr. Christian Webel

Further Information

Homepage of the Living Lab
www.futurelogisticslivinglab.com



Since May 2010, the Fraunhofer Project Center for Transport and Logistics at the “National Information and Communication Technology Research Centre of Excellence, Australia (NICTA)”, under the leadership of Dr. Glenn Geers and in cooperation with Fraunhofer IESE, has been offering research and consulting services in the area of information and communication technologies (ICT) for logistics and intelligent transport management. The Fraunhofer Project Center is an important address for the Australian transport and logistics industry.

The core of the project center, the Future Logistics Living Lab, continued to be successful in 2012 as well. More than 500 government, industry, and research representatives visited the practice-relevant exhibits. In addition, several workshops on current topics were held with the now more than 25 partners, which often led to first research projects. For example, in one of these projects, Fraunhofer IESE and NICTA together with 1-Stop, a participant of the Future Logistics Living Lab, have developed methodologies and technologies that aim to better support business process flexibility and adaptability.

In order to further increase the visibility of the Living Lab and to create a new communication platform, a mobile application for the iPhone was developed. With this app, the user can get information about news, projects, and events concerning the Living Lab. In addition, all the exhibits of the Living Lab are explained and illustrated with pictures. This app does not only serve for external representation, but also helps to connect the Community around the Lab and the issues of transport and logistics. To achieve this purpose, the social business network LinkedIn was integrated into the application. In a separate “Future Logistic Living Lab” group, new topics can be discussed and contacts can be made. It is also possible to subscribe to a newsletter about specific topic areas. Starting in mid-February 2013, the “Future Logistic Living Lab” app is expected to be available for the iPhone in the Apple App Store.

Driver distraction is a significant cause of motor vehicle accidents. With more and more communication, entertainment, safety, and information systems installed in cars, the potential for a high cognitive load and distraction of the driver has increased. In the research project Driver Mental State Monitoring (DMSM), Fraunhofer IESE and NICTA are continuing their work on the effect of cognitive load on User Experience during driving. It focuses on the real-time assessment of drivers’ mental states through behavioral and physiological inputs, in view of improving user experience, safety and training for the automotive industry and for end-users



Future Logistics Living App (left)

A major milestone of this project was a demonstrator at the 19th ITS World Congress in Vienna (right)

The DMSM project explores new technologies that can monitor a driver's mental state in view of:

- Monitoring safety: real-time monitoring of the driver, and the detection of mental states at risk (driver awareness, fatigue, anger...) can help reduce unsafe driving through automated decision support;
- Testing and training drivers: assessing driver reaction in controlled tasks and environments can help ensure the appropriate level of proficiency is attained, especially for specialized vehicles such as trucks or tractors;
- Designing better vehicle user interfaces: usability testing of vehicle controls can help improve the design of safer interfaces and improve user experience.

The project was performed in three main stages:

1. Construction of a simple driving simulator
2. Design and experimental validation of tasks and scenarios
3. Deployment in a real-life simulator

Experimental research has proven the technological feasibility of the project, and now new industrial partners shall be engaged through the demonstration of this technology.

Collaboration Partner

NICTA
<http://www.nicta.com.au/>



Further Reading:

Business Area Automotive and
 Transportation Systems p. 46
 Business Area Information Systems
 p. 52

Fraunhofer Project Center for Software and Systems Engineering in Brazil

Director: Prof. Dr. Manoel Mendonça, UFBA

Deputy Director: Dr. Karina Villela, Fraunhofer IESE

Contact

Dr. Karina Villela

Phone +49 631 6800-2173

Fax +49 631 6800-9 2173

karina.villela@iese.fraunhofer.de



Dr. Karina Villela

The Fraunhofer Project Center for Software and Systems Engineering at UFBA (FPC-UFBA) joins the research competence and industrial practice of the partners, Fraunhofer IESE and the Software Engineering Laboratory of the Federal University of Bahia (UFBA), to boost the development of innovative software solutions for the Brazilian industry. It was officially established on 09 March 2012 and is located in the Technology Park of Bahia, which hosts companies such as IBM, Portugal Telecom Innovation, as well as several big Brazilian companies.

In order to achieve its goal of boosting business innovation through software, FPC-UFBA partners have been working together in public and industrial projects to develop and implement efficient software engineering processes, methods, and techniques that can directly and positively impact companies' business.

One of the projects at FPC-UFBA that started in 2012 aims at merging two independent management information systems for organ donors in Brazil (one for the state of São Paulo and another for all the other Brazilian states) into a single state-of-the-art system. The project customer is the National Coordination Agency for Organ Transplantation, part of the Brazilian Health Ministry. UFBA is in charge of developing the new management information system and Fraunhofer IESE will perform the security audit of the final system.

In addition, FPC-UFBA partners have carried out activities to identify and address the concrete challenges faced by Brazilian software companies or departments when:

- developing or evolving large and/or critical systems
- assuring the quality of software processes and products, especially if they must be compliant with standards and regulations,
- extracting information from large amounts of data to support well-informed decisions,
- making business mobile.

Further Information

Homepage of Project Center
fpc.dcc.ufba.br

**Fraunhofer Project Center
for Software and Systems Engineering
at UFBA**

In cooperation with



Two surveys with an international scope have been designed and are being conducted: One is intended to characterize the effectiveness of the variation management approaches currently used in Brazil for the development of similar systems. This survey is going to be applied in Germany as well, as part of a project concerned with variation management approaches in small and medium-sized companies. The second survey asks software developers from both countries how they work with architecture documentation, which problems they see, and which improvements they request, with the goal of characterizing what architecture documentation is necessary and sufficient to make software development more effective and efficient than today.

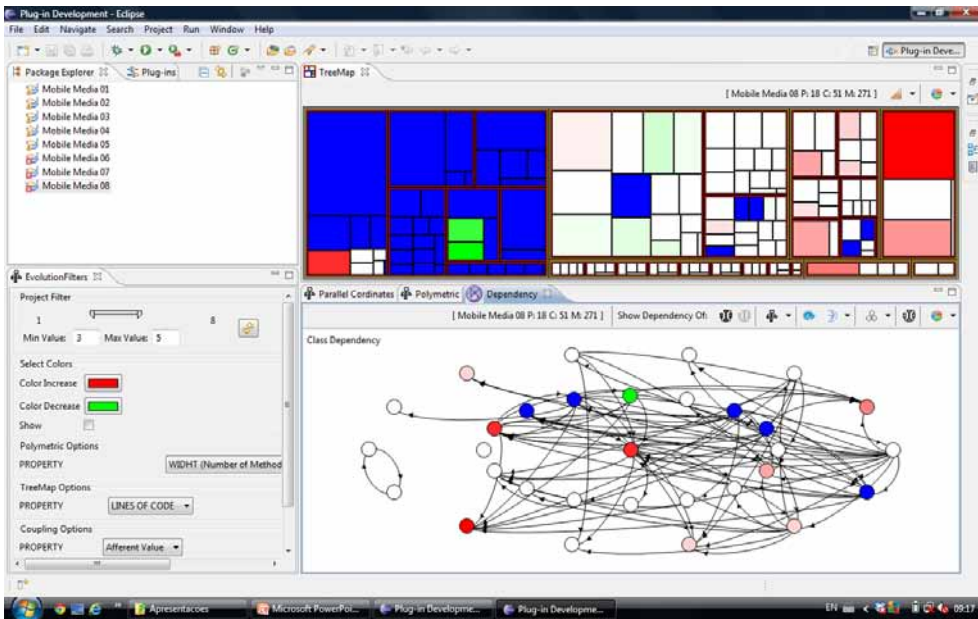

Software evolution visualization tool developed at UFBA to analyze changes and anomalies in critical and large systems, providing a basis for product improvement.

A task that started in 2012 and will continue in 2013 is the establishment of an ICT Demonstration Laboratory for FPC-UFBA on the topic of Mobility. This facility will allow industrial partners and visitors in Brazil to experience how innovative ICT technologies can be used in real-world applications. Industry partners will be closely involved in the development of demonstrators to promote a shared vision of business challenges and break-through ideas and thereby support open innovation. We also plan to provide hands-on business mobile engineering services, including user interface and interaction design, implementation on various platforms, and testing.

Exchange of scientists and participation in specialized fairs are also part of FPC-UFBA's activities. In May, FPC-UFBA presented a mobile software solution for smart farming at the BITS fair, the CeBIT event in South America, which took place in Porto Alegre, Rio Grande do Sul, Brazil. In September, a set of software solutions for supporting the planning and coordination of large events as well as the prevention and handling of emergencies was presented to the state secretaries in charge of planning the upcoming sport events in Brazil, including the 2014 FIFA World Cup and the 2016 Olympic Summer Games.

Collaboration Partner

Brazilian Ministry of Health
<http://www.saude.gov.br>



Ministério da Saúde



Further Reading:

Business Area Medical Devices p. 50

ECOPETROL: Software Quality Modeling in the Oil and Gas Domain

Contact

Dr. Jens Heidrich
Phone +49 631 6800-2193
Fax +49 631 6800-9 2193
jens.heidrich@iese.fraunhofer.de



Dr. Jens Heidrich

Quality is defined as “the totality of characteristics of an entity that bear on its ability to satisfy stated and implied needs” (ISO 8402). Typically, the term “software quality” is hard to capture for an organization. In order to make the concept more operational, software quality models have been defined. These models try to refine the abstract term “quality” of software development products and processes into sub-concepts down to the level of metrics and indicators to allow quality measurement (such as ISO 9126 or its successor ISO 25000).

ECOPETROL is a corporate group headquartered in Colombia, focused on petroleum, gas, petrochemicals and alternative fuels, and recognized for its international positioning, its innovation, and its commitment to sustainable development. In the year 2012, Fraunhofer IESE supported ECOPETROL in its efforts to create a custom-tailored quality model for software applications delivered to their IT department. The initiative was launched under the Vice-Presidency of Innovation and Technology. One of ECOPETROL’s major goals is to become one of the 30 leading companies in the oil and gas domain worldwide by 2020. IT plays an important role in supporting the business processes necessary to establish ECOPETROL’s goals through reliable information in real time. The company supports standardization of business processes and IT based on the premise that standardization and simplification of platforms (an initiative of the IT Enterprise Architecture group) will help it to expand and grow faster and be more agile. The quality model was developed for software that is acquired, maintained, or developed by external suppliers of ECOPETROL’s IT department. The major goal related to developing the quality model was to improve software quality, reduce the issues caused by unknown/probably poor software quality, and in turn contribute to the ability to develop and maintain software faster and support ECOPETROL in becoming more agile.

Collaboration Partner

ECOPETROL S.A.
www.ecopetrol.com.co

The initial model addresses ten high-level quality characteristics related to different artifacts of their development process (such as stability of requirements, adaptability of the source code, external and internal coupling of components, reusability of code, or defect density). The characteristics most important for ECOPETROL were elicited in a survey among its IT experts and as part of a workshop centering on practical issues related to software quality. For these ten characteristics, a total of 50 metrics were derived for their objective evaluation by employing the Goal/Question/Metric (GQM) approach, a de-facto standard for systematically eliciting software metrics.

The quality model was created based upon the GQM input and was implemented based on Fraunhofer IESE’s M-System measurement framework. The M-System accesses different software analysis tools and databases containing measurement data, integrates these data and creates different kinds of visualizations of these data. The figure presents an example visualiza-

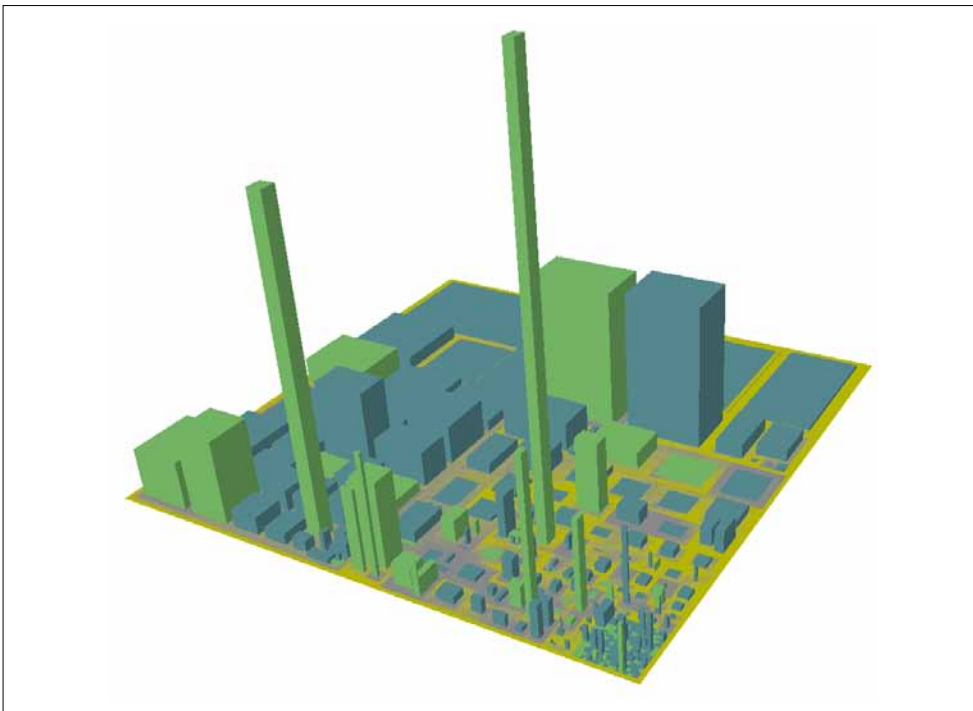

3D tree map of ECOPETROL's Enterprise Architecture (base area of a building equals number of related information units, height equals sum of used and provided interfaces, color equals status field of application)

tion generated by the M-System. It illustrates the overall landscape of the applications used by ECOPETROL. Each application is represented by a building on the three-dimensional tree map. The base area of a building equals the number of related information units, the height equals the sum of the used and provided interfaces, and the color equals the status field of the application. As can be seen, two applications have very high interface complexity (but are fairly small in size) and two other applications are quite large in size and have rather high interface complexity in addition. Using the results from the practical application of the quality model, outliers and potential risky applications in terms of quality can be identified and mechanisms can be set up for dealing with their specific quality characteristics.

In the future, the analysis results will trigger initial recommendations for further improvement of software quality and will lead to the identification of reliable target values for the creation of quality gates as a mechanism for checking software quality as early as possible in the development process. Furthermore, this will help ECOPETROL in defining policies to be followed by the organization in order to standardize quality requirements. In the short term, it will help it to improve, standardize, and adopt artifacts of the software development process.

Further Reading:

- Business Area Automation and Plant Engineering p. 48
- Business Area Information Systems p. 52
- Division Process Management p. 65

JAXA: Evaluating the Quality of Safety-Critical Software Systems

Contact

Dr. Jens Heidrich
Phone +49 631 6800-2193
Fax +49 631 6800-9 2193
jens.heidrich@iese.fraunhofer.de



Dr. Jens Heidrich

Collaboration Partner

Japan Aerospace Exploration
Agency JAXA
<http://www.jaxa.jp>

Managing the quality of different artifacts created during the development process is an integral part of software project management and especially crucial for the development of safety-critical systems.

Software quality models capture the knowledge and experience with respect to which quality characteristics are of interest, which measurement data to collect, and which mechanisms to use for characterizing and assessing software quality. Nowadays, it is still a challenge to come up with suitable quality models for an organization: First, there is no universal model that can be applied in every environment, because quality is heavily dependent on the application domain, the stakeholders, the usage purpose, and the concrete project context. In practice and research, a variety of different quality models exists. Finding the “right” model depends on a clear picture of the goals that should be obtained from using the model. Second, quality models need to be tailored to company specifics and supported by corresponding tools. Existing standards (such as the ISO/IEC 25000 series) are often too generic and hard to fully implement in an organization. Third, in order to create sustainable quality models, their contribution to and value for the organizational goals must be clarified and the models need to be integrated into the development processes (e.g., by defining appropriate quality gates).

As part of an ongoing strategic collaboration with the Japan Aerospace Exploration Agency JAXA, the focus in 2012 was on developing a model for evaluating the quality of safety-critical software of satellite systems delivered by external suppliers. The main idea was to combine the results from a classical safety analysis with a static code analysis for identifying safety-critical software functions and components with bad code quality and, consequently, a high risk of failure. Having such a model allows JAXA to systematically evaluate the source code delivered by its suppliers and to focus its quality assurance activities on the parts of the code rated as being safety-critical and having bad software quality. This effort should further increase the quality of the supplied safety-critical software and in turn enable JAXA to employ high-quality software in satellites and achieve its main mission.



For that purpose, a quality model was developed together with JAXA experts, which focuses on quality characteristics and corresponding metrics for measuring these characteristics that have proven to have a strong impact on the criticality of code in terms of safety. The initial model was created based on information from the literature and with the help of external experts on developing safety-critical systems. Afterwards, the model was tailored to the specific needs of JAXA and enriched with information from a classical Fault Tree Analysis (FTA) based on a mapping table between the identified root causes for system failures and the functions related to those causes.

Rocket launch facilities

Currently, the quality model is being implemented via the Fraunhofer M-System measurement framework, which allows retrieving data from static code analysis tools and provides visualization instruments for browsing the analysis results and interacting with the visualization (e.g., drilling down into the data).

In 2013, the model will be applied to an example system provided by JAXA and will be evaluated by JAXA experts in terms of its practical usage. After integrating final improvement recommendations, it is planned to broaden the scope of the model usage to software that is actually part of recent JAXA satellite systems and to enable JAXA to perform quality evaluation of safety-critical software systems on a larger scale.

Further Reading:

- Business Area Automotive and Transportation Systems p. 46
- Division Process Management p. 65



CONTACT

How to find us	124
Fraunhofer IESE Contact Persons	128
Information Service	131

HOW TO FIND US

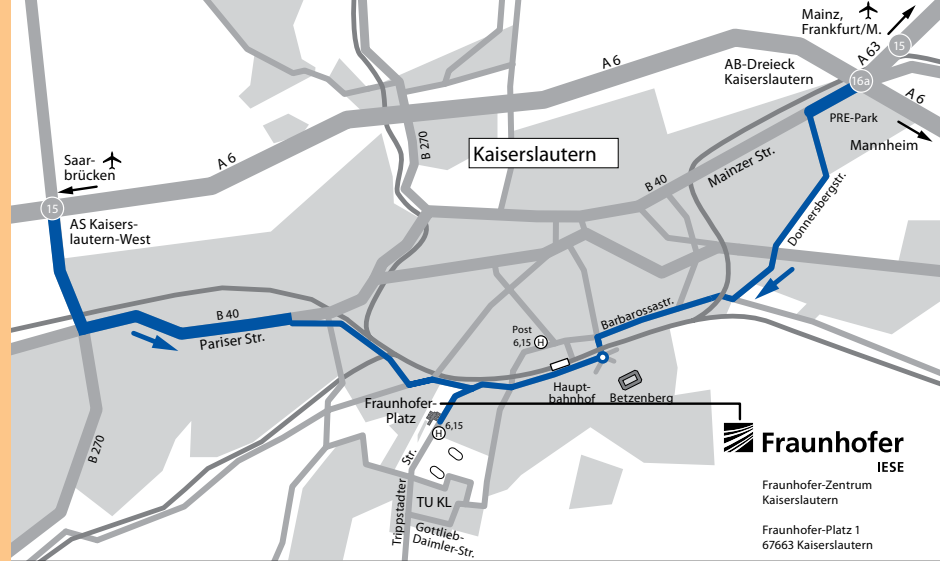

Fraunhofer-Institut für Experimentelles Software Engineering
 Fraunhofer-Platz 1
 67663 Kaiserslautern
 Germany
 Phone +49 631 6800-6000
 Fax +49 631 6800-1099
www.iese.fraunhofer.de

By car

Coming from the West on Autobahn A6, take the exit Kaiserslautern-West (15), then go towards downtown and follow the signs towards the university. Before you get to the university, you will reach the building complex of the Fraunhofer Center a few hundred meters down Trippstadter Strasse, on the right side of the street.

Coming from the East on Autobahn A6, go to the Autobahn Interchange (“Autobahndreieck”) Kaiserslautern, and take the exit Kaiserslautern-Centrum (16a). Then first follow the signs towards Betzenberg Soccer Stadium, then towards the university. It is best to use the detour behind the train station via Zollamtstrasse; at the end of the street, continue straight ahead into Trippstadter Strasse. The building complex of the Fraunhofer Center is located approx. 500m down the street on the right side.

Getting there by means of electronic navigation:

Since most likely, the Fraunhofer-Platz is not yet listed in most electronic navigation systems, we recommend using “Trippstadter Strasse 125” as the destination instead. The Fraunhofer Center is located directly across the street..

By rail and bus

Proceed to the main train station, Kaiserslautern Hauptbahnhof, and then either take a taxi or take TWK city bus no. 106 (towards Mölschbach) or no. 115 (towards Universität), getting off at the stop “Fraunhofer-Zentrum”.

By air

From Frankfurt Rhein Main Airport, either by train (approx. 2 hours) or by rental car (approx. 1.5 hours).

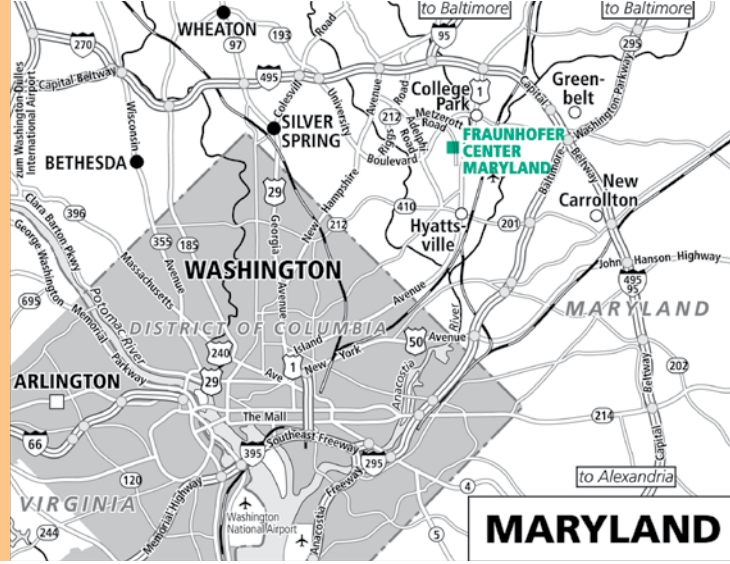

Fraunhofer USA Center for Experimental Software Engineering
 5825 University Research Court
 Suite 1300
 College Park, MD 20740-3823
 USA
 Phone +1 240 487-2905
 Fax +1 240 487-2960
 www.fc-md.umd.edu

By Car

Directions from the North

Take Interstate 95 (I95) South (East part of Washington Beltway, I495). Take Route 201, Kenilworth Avenue exit. At the end of the exit ramp, go right.
 Continue past the light for Paint Branch Parkway / Good Luck Road through one more light. Turn right at light for River Road. After crossing over a small bridge, turn right onto University Research Court.
 Our building is at the end of University Research Court on the right. Go in the front doors in the center of the building.
 We are on the first floor, past the elevators, and to the left.

Directions from the South – traveling northbound on Interstate 95 (I95)

Take I95 North to the Washington Beltway – I 495, going North or towards College Park. Take the exit for Route 50, going west, towards Washington, DC. Take the exit for Route 410, Veterans Highway. At the end of the exit ramp, go right. Continue on 410, crossing through the traffic light at Route 450. The road will come to a “T”, turn left, following the signs for 410. You will pass under the Baltimore/Washington Parkway and through several lights.

At the light for Route 201 Kenilworth Avenue, turn right.
 Turn left onto River Road.
 After crossing over a small bridge, turn right onto University Research Court.
 Our building is at the end of University Research Court on the right. Go in the front doors in the center of the building.
 We are on the first floor, past the elevators, and to the left.

Directions from the Washington, DC area

Take DC-295 North, following signs for the Baltimore/Washington Parkway. Exit at Riverdale Road/Route 410, turning left onto Riverdale Road, which becomes East-West Highway. Go to Route 201 Kenilworth Avenue and turn right. Turn left onto River Road.
 After crossing over a small bridge, turn right onto University Research Court.
 Our building is at the end of University Research Court on the right. Go in the front doors in the center of the building.
 We are on the first floor, past the elevators, and to the left.



Fraunhofer Project Center on Transport and Logistics
 NICTA (National ICT Australia), Sydney
 ATP Research Laboratory & Corporate Head Office
 Australian Technology Park,
 Level 5, 13 Garden Street
 Eveleigh NSW 2015
 Australia

www.nicta.com.au

Main Phone: +61 2 9376 2000

Main Fax: + 61 2 9376 2300

By Car

The entrance to the Australian Technology Park car park is from Henderson Road, Eveleigh. A Pay and Walk ticketing system has been installed for your convenience. Collect a ticket from the boom gate and drive through to the car park located on ground floor of 8 Central Avenue (Media City Building).

Event/ Visitor car parking is available at 8 Central Ave (Media City Building). Collect a ticket from the boom gate and drive through to the Car Park, located at Ground Floor, 8 Central Ave.

By Rail

CityRail operates frequent train services between Redfern Station (adjacent to the Australian Technology Park) and other major Sydney stations including Central, Town Hall, Wynyard and Circular Quay.

For information about travelling by rail, including timetable information, call the Transport Infoline on 131 500 or visit www.131500.com.au

From Redfern Station

Exit via Platform 10 at Redfern Station. Walk past the WaterTower apartment block and follow the walkway through to the Australian Technology Park. Pedestrian access to the Locomotive Workshops are through Bays 1, 4 and 8. For information relating to specific building and tenant location, enter through the side door of Bay 1 and proceed to ATP Precinct Management offices, located on Level 1/Bay 4 Atrium or phone (02) 9209 4220 for further assistance.

By Bus

There are frequent bus services to the Australian Technology Park from the city and Sydney's domestic and international airport. The bus stop closest to the Australian Technology Park is on the corner of Boundary and Regent Street. For bus timetables call the Transport Infoline on 131 500 or visit www.131500.com.au .



Fraunhofer Project Center for Software and
Systems Engineering
Parque Tecnológico de Salvador
Avenida Luiz Viana Filho
Loteamento Colinas do Jaguaribe, Lote M
Salvador, Bahia,
Brazil

fpc.dcc.ufba.br

Contact

Prof. Dr. Manoel Mendonça
Phone: + 55 71 3283-6311
Email: manoel.mendonca@ufba.br

By car

Coming from Salvador

Follow the Avenida Luiz Viana Filho (also known as Paralela) in the direction of the airport. The Technology Park is located approximately at the level of the former “Wet’n Wild” waterpark and current festival area on the left side.

Shortly after the exit “Bairro da Paz” (do not use this exit!), you can make a U-turn (“Retorno”) on the left side to get on the opposite lane leading back into the city. Make this U-turn and take the first exit on the right to get to the Technology Park.

Follow the driveway up to the large orange building in which our offices are located. Parking is available in front of the building.

Coming from the airport

Exit the airport towards the center of Salvador using the Avenida Luiz Viana Filho (also known as Paralela). After about 6 kilometers, the entrance to the Technology Park is on the right side.

Follow the driveway to the large orange building in which our offices are located. Parking is available in front of the building.

Remarks

Taking a bus is not recommended, as no adequately developed public transport system exists yet in the area of the Technology Park.

Instead, we recommend taking a taxi. It is a little more expensive, but also safer to take a taxi using the official taxi companies situated inside the airport building (or ask at the information booth). If you are arriving from the city, pre-order a taxi by telephone.

FRAUNHOFER IESE CONTACT PERSONS

Dial Phone No.
+49 631 6800- ...

Executive Board

1001 Prof. Dieter Rombach
Executive Director
dieter.rombach@iese.fraunhofer.de



1101 Prof. Peter Liggesmeyer
Scientific Director
peter.liggesmeyer@iese.fraunhofer.de



1201 Prof. Frank Bomarius
Director of Operations
frank.bomarius@iese.fraunhofer.de



Staff Functions

1205 Holger Westing
Managing Director
Department Head Central Services
holger.westing@iese.fraunhofer.de



1002 Nicole Spanier-Baro
Head of PR / Marketing
nicole.spanier-baro@iese.fraunhofer.de



2239 Sonnhild Namingha
International Staff Advisor
Student Exchange Program
sonnhild.namingha@iese.fraunhofer.de



Division Managers

Department Heads

2272 Dr. Mario Trapp
Division
Embedded Systems
mario.trapp@iese.fraunhofer.de



2246 Dr. Martin Becker
Embedded Systems Development
(ESD)
martin.becker@iese.fraunhofer.de



2218 Sören Kemmann
Embedded Systems Quality
Assurance (ESQ)
soeren.kemmann@iese.fraunhofer.de



2193 Dr. Jens Heidrich
Division
Process Management
jens.heidrich@iese.fraunhofer.de



2260 Dr. Andreas Jedlitschka
Measurement, Prediction &
Empiricism (MPE)
andreas.jedlitschka@iese.fraunhofer.de



2103 Rolf Hendrik van Lengen
Process Compliance & Improvement
(PCI)
rolf.van.lengen@iese.fraunhofer.de



1601 Dr. Jörg Dörr
Division
Information Systems
joerg.doerr@iese.fraunhofer.de



2186 Dr. Marcus Trapp
Information Systems Development
(ISD)
marcus.trapp@iese.fraunhofer.de



2181 Michael Eisenbarth
Information Systems Quality
Assurance (ISQ)
michael.eisenbarth@iese.fraunhofer.de



Dial Phone No.
+49 631 6800- ...

Business Area Managers

1603 Ralf Kalmar
Produkt Industries
- Automotive and Transportation Systems
- Automation and Plant Engineering
- Medical Devices
ralf.kalmar@iese.fraunhofer.de



1604 Michael Ochs
IT and Service Industries
- Information Systems
Finance, ERP/Software, Telecommunication
- eGovernment
- Health Care
michael.ochs@iese.fraunhofer.de



International Coordinators

2272 Dr. Mario Trapp
USA
mario.trapp@iese.fraunhofer.de



2185 Dr. Christian Webel
Australia
christian.webel@iese.fraunhofer.de



2173 Dr. Karina Villela
Brazil
karina.villela@iese.fraunhofer.de



2193 Dr. Jens Heidrich
Japan / Asia
jens.heidrich@iese.fraunhofer.de



INFORMATION SERVICE

Fraunhofer-Institut für
Experimentelles Software Engineering
Fraunhofer-Platz 1

67663 Kaiserslautern
Germany

To receive further information, please fax us
a copy of this page.

Fax +49 631 6800-1099

Further Information

- Annual Report 2012/2013 of Fraunhofer IESE, print version (German)
- Annual Report 2012/2013 of Fraunhofer IESE, print version (English)
- Annual Report 2012/2013 of Fraunhofer IESE, CD-ROM version (German & English)
- Short films of Fraunhofer IESE, DVD, German
- Short films of Fraunhofer IESE, DVD, English
- Fraunhofer IESE: Overview
- The Fraunhofer-Gesellschaft from A-Z
- Annual Report of Fraunhofer-Gesellschaft
- STI Software Technologie Initiative Kaiserslautern e. V.
- Please add my address

A PDF file of the Fraunhofer IESE Annual Report 2012/2013 with included Appendix and other publications (press releases, previous Annual Reports) are available at

www.iese.fraunhofer.de

Fraunhofer IESE Point of Contact:

Nicole Spanier-Baro
Head of PR / Marketing
Phone +49 631 6800-6000
Fax +49 631 6800-1099
presse@iese.fraunhofer.de



Return Address

Title

Last Name, First Name

Company

Position

Department

Address

Zip Code / City

Phone

Fax

E-mail



APPENDIX

Network in Science and Industry	134
Industrial Partners	134
National Research Partners	136
International Research Partners	136
International Software Engineering Network (ISERN)	137
Visitors Hosted	138
Professional Contributions	139
Lecturing Assignments	139
Editorial Boards	140
Committee Activities	141
Scientific and Technological Advisory Boards	144
Participation in Delegations	144
Memberships in Industrial Advisory Boards	144
Memberships in Professional Associations	145
Keynotes	145
Presentations	146
Scientific Contributions	150
Books	150
Articles in Books	150
Articles in Journals	151
Contributions to Conference Proceedings	152
Proceedings by Editors	156
Fraunhofer IESE Reports	156
Other Technical Reports	159
Doctoral Theses	160
Master's Theses	160
Bachelor's Theses	160
Awards	161
Internal Awards	161
External Awards	161

NETWORK IN SCIENCE AND INDUSTRY

INDUSTRIAL PARTNERS¹

- 1&1 Internet AG, Karlsruhe
- a 3 systems GmbH, Zweibrücken
- Ab.Acus srl, Milan, Italy
- ABB AG, Mannheim
- Absint Angewandte Informatik GmbH, Saarbrücken
- Accellere GmbH, St. Augustin
- Adam Opel GmbH, Rüsselsheim
- Agentilo GmbH, Kaiserslautern
- Airbus Operations GmbH, Hamburg
- ALENIA SIA SPA, Turin, Italy
- ALSTOM Transport S.A., Levallois Perret, France
- Alte Leipziger Lebensversicherung auf Gegenseitigkeit, Oberursel (Taunus)
- andrena objects ag, Karlsruhe
- Ansaldo Sts, Genova, Italy
- Audi AG, Ingolstadt
- Audi Electronics Venture GmbH, Gaimersheim
- AVL LIST GmbH, Graz, Austria
- B2M Software AG, Karlsruhe
- BASF SE, Ludwigshafen
- Berlin Heart GmbH, Berlin
- Berner & Mattner Systemtechnik GmbH, Munich
- Binder Elektronik GmbH, Sinsheim
- BMW Group Forschung und Technik GmbH, Munich
- BrandMaker GmbH, Karlsruhe
- BTC Business Technology Consulting AG, Berlin
- BTC Embedded Systems AG, Oldenburg
- Cassidian Systems, Immenstaad am Bodensee
- CAS Software AG, Karlsruhe
- CIBEK technology + trading GmbH, Limburgerhof
- Cisco Systems GmbH, Stuttgart
- Comlet Verteilte Systeme GmbH, Zweibrücken
- Continental Automotive GmbH, Hanover
- Continental Teves AG & Co. oHG, Frankfurt
- ConWeaver GmbH, Darmstadt
- Corisecio GmbH, Darmstadt
- CosmosDirekt, Saarbrücken
- Daimler AG, Ulm
- Dassault Systèmes, Suresnes, France
- DENSO AUTOMOTIVE Deutschland GmbH, Eching
- Deutsche Bahn AG, Berlin
- Deutsche Bausparkasse Badenia AG, Karlsruhe
- Deutsche Lufthansa AG, Frankfurt
- Deutsche Telekom AG, Neuss
- Diehl Aerospace GmbH, Überlingen
- DIOCert GmbH, Erkrath
- EADS Deutschland GmbH, Munich
- Eaton Electric BV, Hengelo, The Netherlands
- Eckert & Ziegler BEBIG GmbH, Berlin
- ECOPETROL S.A., Bogotá, Colombia
- Elektrobit Automotive GmbH, Erlangen
- Elma Trenew Electronic GmbH, Pforzheim
- ETAS Entwicklungs- und Applikationswerkzeuge für elektronische Systeme GmbH, Stuttgart
- EUROSEC GmbH, Kronberg
- Eyed GmbH, Saarbrücken
- Finanz Informatik GmbH & Co.KG, Frankfurt
- Firma Vitaphone GmbH, Mannheim
- Ford Forschungszentrum Aachen GmbH, Aachen
- ForTISS GmbH, Garching
- Fredhopper, Amsterdam, The Netherlands
- FTI Engineering Network GmbH, Blankenfelde-Mahlow
- Fujitsu Laboratories of Europe Ltd., Hayes, UK
- Gemeinsame Klassenlotterie der Länder (GKL), Munich
- Gigaset Communications GmbH, Bocholt
- Globus SB-Warenhaus Holding GmbH & Co. KG, St. Wendel
- Hapag-Lloyd AG, Hamburg
- Hocoma AG, Volketswil, Switzerland
- ICT Solutions AG, Trier
- IDCH Germany GmbH, Lemberg
- IDS Scheer, Saarbrücken
- IHK Darmstadt Service GmbH, Darmstadt
- IMACS GmbH, Bad Kreuznach/Planig
- IMC AG, Saarbrücken
- INCHRON GmbH, Potsdam
- Infinion Technologies, Neubiberg
- Insiders GmbH, Kaiserslautern
- intelligent views gmbh, Darmstadt
- Itemis AG, Lünen
- itestra GmbH, Kaufering
- IT Power Consultants, Berlin
- ITTI Sp. Z o.o., Poznan, Poland
- John Deere European Technology Innovation Center, Kaiserslautern
- John Deere Moline Technology Innovation Center, Moline, USA

1) Industrial Partners are located in Germany unless stated otherwise.

- Knorr-Bremse, Schwieberdingen
- KOBIL Systems GmbH, Worms
- Krauss-Maffei Wegmann GmbH & Co. KG, Kassel
- Liebherr-Aerospace, Lindenberg
- LIEBHERR-FRANCE SAS, Colmar, France
- Lufthansa Systems Passenger Services GmbH, Raunheim
- Medcom Gesellschaft für medizinische Bildverarbeitung mbH, Darmstadt
- Metropolregion Rhein-Neckar GmbH, Mannheim
- mineway GmbH, Saarbrücken
- Morpho, Paris, France
- Murex S.A.S., Paris, France
- N.A.T. GmbH, St. Augustin
- Netbiscuits GmbH, Kaiserslautern
- Ontoprise GmbH, Karlsruhe
- OpenSynergy GmbH, Berlin
- OrgaTech Unternehmensberatung, Lünen
- Philips Consumer Lifestyle Advanced Technology, Eindhoven, The Netherlands
- Polarian Software GmbH, Stuttgart
- Porsche Engineering Group GmbH, Weissach
- proALPHA Software AG, Weilerbach
- pure-systems GmbH, Magdeburg
- QA Systems GmbH, Stuttgart
- RadiSys GmbH, Hallbergmoos
- Rand Europe, Cambridge, UK
- R&D-Ware Oy, Espoo, Finland
- Robert-Bosch GmbH, Stuttgart
- RST Industrie Automation GmbH, Ottobrunn
- SAP AG, Walldorf
- Schalker Eisenhütte Maschinenfabrik GmbH, Gelsenkirchen
- Schenker AG, Essen
- SEEBURGER AG, Bretten
- SIEDA GmbH, Kaiserslautern
- Siemens AG, Munich
- Sirrix AG, Saarbrücken
- Software AG, Darmstadt
- Sopera GmbH, Bonn
- SOPHIST GmbH, Nuremberg
- SWK Stadtwerke Kaiserslautern GmbH, Kaiserslautern
- SWM Services GmbH, Munich
- Sysgo AG, Klein-Winternheim
- TecNet GmbH, Berlin
- THALES, Neuilly sur Seine, France
- TKMS Blohm+Voss Nordseewerke GmbH, Hamburg
- T-Systems Enterprise Services GmbH, Frankfurt
- TÜV SÜD Automotive GmbH, Munich
- Ubigrate GmbH, Dresden
- UplinkIT GmbH, Kaiserslautern
- User Interface Design GmbH, Ludwigsburg
- Vallomed GmbH, Castrop-Rauxel
- Vector Informatik GmbH, Stuttgart
- Volkswagen Aktiengesellschaft, Wolfsburg
- Volvo Technology Corporation, Göteborg, Sweden
- WIKON Kommunikationstechnik GmbH, Kaiserslautern
- Wind River GmbH, Ismaning
- XiSys Software GmbH, Randersacker
- ZF Friedrichshafen AG, Friedrichshafen

NATIONAL RESEARCH PARTNERS

- Berufsbildungswerk Gemeinnützige Bildungseinrichtung des DGB mbH, Erkrath
- CyberForum e.V., Karlsruhe
- DESY Deutsches Elektronen-Synchrotron, Hamburg
- Deutsches Forschungszentrum für Künstliche Intelligenz GmbH (DFKI) (German Research Center for Artificial Intelligence GmbH), Kaiserslautern/Saarbrücken
- Deutsche Informatik-Akademie (DIA), Bonn
- Deutsches Institut für angewandte Pflegeforschung e.V., Cologne
- Deutsche Stiftung für chronisch Kranke, Fürth
- Deutsches Zentrum für Luft- und Raumfahrt e.V. (German Aerospace Center), Cologne
- Fachbereich Maschinenbau, Fachhochschule Kaiserslautern (Department of Mechanical Engineering, Kaiserslautern University of Applied Sciences), Kaiserslautern
- Fachbereich Mensch-Maschine-Systeme, Technische Universität Berlin
- Forschungszentrum Informatik (FZI) (Research Center for Information Technologies), Karlsruhe

- Hessisches Landesamt für Straßen- und Verkehrswesen (Hessian State Office for Roads and Traffic), Frankfurt
- Hochschule für Technik und Wirtschaft des Saarlandes (Saarland University of Applied Science), Saarbrücken
- Humboldt-Universität zu Berlin, Berlin
- INI-GraphicsNet Stiftung, Darmstadt
- Institut für Arbeit und Technik, Gelsenkirchen
- Institut für Informatik IV, Technische Universität München (Institute for Computer Science, TU München), Munich
- Institut für Medizinische Biometrie und Informatik, Universitätsklinikum Heidelberg (Institute for Medical Biometry and Informatics, Heidelberg University Hospital), Heidelberg
- Institut für Technische und Betriebliche Informationssysteme, Otto-von-Guericke-Universität Magdeburg (Department of Technical & Business Information Systems, Otto von Guericke University), Magdeburg
- Lehrstuhl für Software Systeme, Universität Duisburg-Essen (Institute for Computer Science and Information Systems, University of Duisburg-Essen), Essen

- Oldenburger Forschungs- und Entwicklungsinstitut für Informatik-Werkzeuge und -Systeme OFFIS e.V. (Oldenburg Research and Development Institute for Computer Science Tools and Systems), Oldenburg
- Regierungspräsidium Gießen (Gießen Regional Administrative Authority), Gießen
- Stadt Kaiserslautern (City of Kaiserslautern)
- Technische Universität Carolo-Wilhelmina, Braunschweig
- Technische Universität Darmstadt, Darmstadt
- Technische Universität Dresden, Dresden
- Technische Universität Kaiserslautern (University of Kaiserslautern), Kaiserslautern
- Technologie-Initiative SmartFactory KL e.V., Kaiserslautern
- Universität Paderborn, Paderborn
- Universität Würzburg, Würzburg
- VDI/VDE Innovation + Technik GmbH (VDI - The Association of German Engineers), Berlin
- Westpfalz-Klinikum GmbH, Kaiserslautern
- Zentralinstitut für Seelische Gesundheit (ZI) (Central Institute of Mental Health), Mannheim

INTERNATIONAL RESEARCH PARTNERS

- Aalborg Universitet, Aalborg, Denmark
- Aristotle University of Thessaloniki, Thessaloniki, Greece
- Bay Zoltan Foundation for Applied Research, Budapest, Hungary
- C-Base, Center for Empirically Based Software Engineering, Maryland, USA
- Centre National de la Recherche Scientifique, Paris, France
- Centro Ricerche Fiat, Turin, Italy
- Chalmers Tekniska Högskola Aktieföretag, Göteborg, Sweden
- Clemson University, Clemson, USA
- College of the Holy and Undivided Trinity of Queen Elizabeth, Dublin, Ireland
- Eidgenössische Technische Hochschule (Swiss Federal Institute of Technology), Zurich, Switzerland
- European Software Institute, Zamudio, Spain
- Experimental Software Engineering Group (UMD/ESEG), University of Maryland, College Park, USA
- Graz University of Technology, Graz, Austria
- Hungarian Association for Home Care and Hospice, MOH, Budapest, Hungary
- Information-technology Promotion Agency, Tokyo, Japan

- Institut National de Recherche en Informatique et Automatique, Le Chesnay, France
 - Instituto de Ciencias Matemáticas de Computação, Universidade de São Paulo, São Paulo, Brazil
 - International Security and Counterterrorism Academy, Rishon Letzion, Israel
 - Japan Aerospace Exploration Agency JAXA, Tokyo, Japan
 - Katholieke Universiteit Leuven, Leuven, Belgium
 - Koninklijke Marechaussee, The Hague, The Netherlands
 - Korps Landelijke Politiediensten, The Hague, The Netherlands
 - Kungliga Tekniska Högskolan, Stockholm, Sweden
 - Lulea Tekniska Universitet, Lulea, Sweden
 - National ICT Australia (NICTA), Eveleigh, Australia
 - National Technical University of Athens, Athens, Greece
 - Norwegian University of Science & Technology, Trondheim, Norway
 - Office National d'Etudes et de Recherche Aéropatiales, Chatillon, France
 - Peace Research Institute Oslo, Oslo, Norway
 - Politecnico di Milano, Milan, Italy
 - Poznan University of Technology, Poznan, Poland
 - Stichting Centrum voor Wiskunde en Informatica, Amsterdam, The Netherlands
 - TNO, Delft, The Netherlands
 - Universidad Politécnica de Madrid, Madrid, Spain
 - Universidad Politécnica de Valencia, Valencia, Spain
 - Universidade Estadual da Paraíba, Campina Grande, Brazil
 - Universidade Federal da Bahia, Salvador, Brazil
 - Università degli Studi di Trieste, Trieste, Italy
 - Università di Bologna, Bologna, Italy
 - Universitetet i Oslo, Oslo, Norway
 - University of Manchester, Manchester, UK
 - Vienna University of Technology, Vienna, Austria
- INTERNATIONAL SOFTWARE ENGINEERING NETWORK (ISERN)**
- Aalto University School of Science and Technology (TKK), Dept. of Computer Science and Engineering, Finland
 - ABB Corporate Research, USA
 - Avaya Labs Research, Software Technology Research Dept., USA
 - Blekinge Institute of Technology (BTH), Sweden
 - COPPE/Rio de Janeiro Federal University, Brazil
 - Fraunhofer Center for Experimental Software Engineering Maryland CESE, USA
 - Fraunhofer Institute for Experimental Software Engineering IESE, Germany
 - Free University of Bolzano-Bozen, Italy
 - Information-Technology Promotion Agency (IPA), Japan
 - Institute of Software, Chinese Academy of Sciences (ISCAS) - Lab for Internet Software Technology, China
 - IT University Copenhagen, Denmark
 - Japan Manned Space Systems Corporation (JAMMS), Japan
 - Japan Aerospace Exploration Agency (JAXA), Japan
 - Kalemun Research Inc., Canada
 - Leiden University, The Netherlands
 - Lund University, Sweden
 - Massachusetts Institute of Technology, USA
 - Microsoft Research, USA
 - Nara Institute of Science and Technology, Japan
 - Naval Postgraduate School, USA
 - North Carolina State University, USA
 - Northrop Grumman, USA
 - Norwegian University of Science and Technology, Norway
 - NTT Data Corporation, Japan
 - Osaka University, Japan
 - Queens University, Belfast, UK
 - Robert BOSCH GmbH, Germany
 - Simula, Norway
 - SINTEF, Norway
 - Technische Universität München, Germany
 - Universidad Politécnica de Madrid, Spain
 - Universidad Politécnica de Valencia, Spain
 - Università degli Studi dell'Insubria, Italy
 - Università degli Studi di Roma Tor Vergata, Italy
 - University of Alabama, USA
 - University of Alberta, Canada
 - University of Auckland, New Zealand
 - University of Bari, Italy

- University of Calgary, Canada
- University of Castilla-La Mancha, Spain
- University of Hawaii, USA
- University of Helsinki, Finland
- University of Kaiserslautern, Germany
- University of Maryland-Baltimore County, USA
- University of Maryland-College Park, USA
- University of New South Wales, Australia
- University of Oslo, Norway
- University of Oulu, Finland
- University of Sheffield, UK
- University of Southern California, USA
- University of Stuttgart, Germany
- University of Technology Sydney, Australia
- University Politecnico di Torino, Italy
- University of Uruguay (ORT), Uruguay
- USC's Information Sciences Institute, USA
- Vienna University of Technology, Austria
- VTT Electronics, Finland

VISITORS HOSTED

Prof. Dr. Elisa Yumi Nakagawa, Professor, Dept. of Computer Systems, USP - University of São Paulo, São Carlos, Brazil, February 1, 2011 - January 31, 2012

Daniel Cardoso de Moraes, Bachelor student, Dept. of Electrical Engineering, Universidad Federal de Campina Grande, Campina Grande, Brazil, September 17, 2011 - February 28, 2012

Felipe de Farias Viana, Bachelor student, Dept. of Mechanical Engineering, Universidad Federal da Paraíba, João Pessoa, Brazil, September 17, 2011 - February 28, 2012

Liher Granado Lopez de Letona, Master student, MGEP (Mondragon Goi Eskola Politekniko), Mondragon, Spain, October 1, 2011 - June 30, 2012

Dr. Damiano Zanardini, Post-Doctoral Researcher, Departamento de Inteligencia Artificial, Facultad de Informática UPM, Boadilla Del Monte, Spain, Mar 1 - April 30, 2012

Mark Staples, Principal Researcher, Software Systems Research Group, NICTA, Sydney, Australia, June 11-15, 2012

Carlos de Mello Rodrigues Coelho, Manager of Technological Projects, Unit of Technological Processes and Products; Sergio Poliano Villarreal, Coordinator of the Simulation Team, Automation and Simulation Technological Center, Brazil's National Service of Industrial Apprenticeship, Rio de Janeiro, Brazil, September 25, 2012

Paulo Alberto Violada, Project Manager, Information Technology Department, Brazil's National Service of Industrial Apprenticeship, Florianópolis, Brazil, October 2, 2012

Prof. Dr. Adolfo Almeida Duran, Prof. Dr. Paulo Alberto Almeida, Prof. Dr. Claudio Cardoso, Prof. Dr. Christina Chavez, Prof. Dr. Manoel Mendonça, Prof. Dr. Claudio Santanna, Prof. Dr. Vaninha Veira dos Santos, Dept. of Computer Science, Federal University of Bahia, Salvador, Bahia, Brazil, October 15-19, 2012

Dr. Emanuela Cartaxo, Post-Doctoral Fellow, Department of Systems and Computation, Federal University of Campina Grande, Campina Grande, Brazil, November 1, 2012 - August 31, 2013

Prof. Dr. Rafael Prikladnicki, Director, Technological Management Agency, Pontifical Catholic University of Rio Grande do Sul, Porto Alegre, Brazil, November 12-16, 2012

PROFESSIONAL CONTRIBUTIONS

LECTURING ASSIGNMENTS

Becker, M.:

Lecture
Product Line Engineering,
Computer Science Dept.,
University of Kaiserslautern
Winter 2011/2012

Bomarius, F.:

Lecture
PDA- Programmierung und
Datenstrukturen, Mechatronics,
University of Applied Sciences
Kaiserslautern
Winter 2011/2012
Winter 2012/2013

Lecture
SEES- SW Engineering fuer
eingebettete Systeme, Mechatronics,
University of Applied Sciences
Kaiserslautern
Winter 2011/2012
Winter 2012/2013

Lecture
OOSE- Objektorientiertes SW
Engineering, Mechatronics,
University of Applied Sciences
Kaiserslautern
Summer 2012
Summer 2013

Lecture
RA- Einfuehrung in Rechnerarchitekturen,
Mechatronics,
University of Applied Sciences
Kaiserslautern
Summer 2012
Summer 2013

Dörr, J.:

Lecture
Requirements Engineering,
Computer Science Dept.,
University of Kaiserslautern
Winter 2011/2012
Winter 2012/2013

Goepfert, B.:

Lecture
Organization of Internal
Information Centers, Faculty
III Media, Information and
Design, University of Applied
Sciences and Arts of Hanover
Winter 2011/2012
Winter 2012/2013

Knodel, J.:

Lecture
Framework-based GUI Development,
Computer Science Dept.,
University of Applied Sciences
Kaiserslautern
Winter 2011/2012

Lecture
Software Maintenance and
Evolution, Computer Science
Dept., University of Applied
Sciences Mannheim
Summer 2012

Lecture
Software Architecture,
Computer Science Dept.,
University of Applied Sciences
Mannheim
Summer 2013

Liggesmeyer, P.:

Lecture
Sicherheit und Zuverlässigkeit
eingebetteter Systeme,
Computer Science Dept.,
University of Kaiserslautern
Winter 2011/2012
Winter 2012/2013

Lecture
Qualitätsmanagement von
Software und Systemen,
Computer Science Dept.,
University of Kaiserslautern
Winter 2011/2012

Lecture
Software-Qualitätssicherung,
Computer Science Dept.,
University of Kaiserslautern
Winter 2012/2013

Lecture
Software-Entwicklung 2,
Computer Science Dept.,
University of Kaiserslautern
Summer 2012

Naab, M.:

Seminar
Softwarearchitektur,
Information und Kommunikation,
Fraunhofer Academy
April 1, 2012
October 1, 2012

Putz, W.:

Lecture
XML-Sprachfamilie, Computer
Science Department,
Hochschule Darmstadt
Winter 2011/2012

Rombach, D.:

Lecture
Grundlagen des Software
Engineering, Computer
Science Dept., University of
Kaiserslautern
Winter 2011/2012
Winter 2012/2013

Lecture
Software Project and Process
Management; Computer
Science Dept., University of
Kaiserslautern
Summer 2012
Summer 2013

Lecture
Empirical Model Building and
Methods, Computer Science
Dept., University of Kaiserslautern
Summer 2012
Summer 2013

Lecture
Requirements Engineering,
Computer Science Dept.,
University of Kaiserslautern
Winter 2011/2012

Lecture
Product Line Engineering,
Computer Science Dept.,
University of Kaiserslautern
Winter 2011/2012

Master Project
Software Engineering: Software
Evolution, Computer
Science Dept., University of
Kaiserslautern
Winter 2011/2012
Winter 2012/2013

Master Project
Software Engineering: Team-
based Software Development,
Computer Science Dept.,
University of Kaiserslautern
Winter 2011/2012
Winter 2012/2013

Simon, K.:

Lecture
Entwicklung angriffssicherer
Software, Computer Sciences
/ Microsystems Technology
Dept., University of Applied
Sciences Kaiserslautern/
Zweibrücken
Summer 2012

Trapp, Mario:

Automotive Software Engineering, Computer Science Department, University of Kaiserslautern
Summer 2012
Summer 2013

Weitzel, B.:

Lecture
Frameworkbasierte GUI-Entwicklung, Computer Sciences / Microsystems Technology Dept., University of Applied Sciences Kaiserslautern/ Zweibrücken
Winter 2011/2012

Wessner, M.:

Lecture
Ambient Intelligent Systems - MP5, Media Dept., University of Applied Sciences Darmstadt
Winter 2011/2012
Winter 2012/2013

Lecture

Cooperative Work & Learning Spaces - MP4, Media Dept., University of Applied Sciences Darmstadt
Summer 2012

EDITORIAL BOARDS

Bomarius, F.:

Member, Editorial Board, Ph.D. Theses in Experimental Software Engineering, Fraunhofer IRB Publishing Company, since 2001

Dörr, J.:

Journal Reviewer, Business & Information Systems Engineering, since 2010

Journal Reviewer, The Computer Journal, since 2011

Journal Reviewer, Requirements Engineering Journal, since 2011

Journal Reviewer, Empirical Software Engineering Journal, since 2012

Journal Reviewer, Information and Software Technology Journal, since 2012

Jung, C.:

Journal Reviewer, Advances in Software Engineering, since 2012

Klaus, A.:

Member Editorial Board, International Journal On Advances in Systems and Measurements, since 2012

Liggesmeyer, P.:

Editor, it – information technology, Oldenbourg-Verlag, München, since 2003

Member, Editorial Board, Lecture Notes in Informatics (LNI), Gesellschaft für Informatik GI, Springer, since 2003

Editor, Informatik – Forschung und Entwicklung, Springer, since 2000

Member, Editorial Board, Ph.D. Theses in Experimental Software Engineering, Fraunhofer IRB Publishing Company, since 2004

Member, Editorial Board, Informatik-Spektrum, since 2012

Luiz, T.:

Coordinating Editor, Medizinische Gefahrenabwehr, since 2009

Münch J.:

Co-Guest Editor, Software Process Improvement and Practice Journal, John Wiley and Sons, since 2006

Member, Editorial Board, e-Informatica, since 2006

Rombach, D.:

Associate Editor, International Journal of Empirical Software Engineering, Springer-Verlag, since 1996

Member, Editorial Board, International Journal of Software Process:

Improvement and Practice, John Wiley and Sons, since 1994

Member, Editorial Board, Ph.D. Theses in Experimental Software Engineering, Fraunhofer IRB Publishing Company, since 2001

Member, Editorial Board, International Journal of Software and Informatics, Institute of Software, Chinese Academy of Sciences, Beijing, since 2007

Schwarz, R.:

Reviewer, IEEE Transactions on Dependable and Secure

Computing (TDSC), since 2012

Trapp, Mario:

Journal Reviewer, IEEE Software, since 2010

Journal Reviewer, Elsevier Journal on Systems and Software, since 2010

Journal Reviewer, IEEE Transactions on Systems, Man, and Cybernetics, since 2010

Journal Reviewer, IEEE Transactions on Software Engineering, since 2008

Villela, K.:

Reviewer Journal Papers, Information and Software Technology/Elsevier, since 2012

Reviewer Journal Papers, ACM Transactions on Software Engineering and Methodology, since 2013

Wessner, M.:

Member, Editorial Board, Journal of Educational Multimedia and Hypermedia, Association for the Advancement of Computing in Education, Chesapeake, USA, since 2005

Member, Editorial Review Board, Journal of Educational Multimedia and Hypermedia, since 2005

Member, Editorial Board, International Journal of Computer-Supported Collaborative Learning, since 2008

Member, Editorial Review Board, Journal of Interactive Learning Research, since 2009

COMMITTEE ACTIVITIES**Adam, S.:**

PC-Member, BPMDS 2012, Gdansk, Poland, June 25-26, 2012

Becker, M.:

Program Committee, SPLC Industry Track, SPLC 2012, Salvador, Brazil, September 2-7, 2012

Program Committee, PLEASE Workshop, ICSE 2012, Zurich, Switzerland, June 4, 2012

Program Committee, VARSA Workshop, WICSA, Helsinki, Finland, August 20, 2012

Program Co-Chair, SPLC FM-SPLE Workshop, SPLC 2012, Salvador, Brazil, September 2-7, 2012

Carbon, R.:

Track Chair, Quality in Web and Mobile Engineering, 8th International Conference on the Quality of Information and Communications Technology (QUATIC 2012), Lisbon, Portugal, September 03-06, 2012

Posters/Demos Co-Chair, 4th International Conference on Mobile Computing, Applications and Services (Mobicase 2012), Seattle, USA, October 11-12, 2012

PC Member, 9th International Conference on the Quality of Information and Communications Technology (QUATIC 2013), Lisbon, Portugal, September 03-06, 2013

PC Member, 4th International Conference on Mobile Computing, Applications and Services (Mobicase 2013), Seattle, USA, October 11-12, 2013

Dörr, J.:

PC Member, Reconf 2012, Munich, Germany, March 12-15, 2012

Co-Organizer, Empirical Track Chair, 18th International Working Conference on Requirements Engineering: Foundation for Software Quality (REFSQ 2012), Essen, Germany, March 19-22, 2012

Co-Organizer, CREARE Workshop, 18th International Working Conference on Requirements Engineering: Foundation for Software Quality (REFSQ 2012), Essen, Germany, March 19, 2012

PC Member, 18th International Working Conference on Requirements Engineering: Foundation for Software Quality (REFSQ 2012), Essen, Germany, March 19-22, 2012

Steering Committee Member, 18th International Working Conference on Requirements Engineering: Foundation for Software Quality (REFSQ 2012), Essen, Germany, March 19-22, 2012

PC Member, IWSPM 2012, 18th International Working Conference on Requirements Engineering: Foundation for Software Quality (REFSQ 2012), Essen, Germany, March 19, 2012

PC Member, REEW 2012, 18th International Working Conference on Requirements Engineering: Foundation for Software Quality (REFSQ 2012), Essen, Germany, March 19, 2012

Reviewer - Fast Abstracts, COMPSAC 2012, Izmir, Turkey, July 16-20, 2012

PC Member, Repos 2012: First International Workshop on Requirements Engineering Practices On Software Product Line Engineering, SPLC 2012, Salvador, Brazil, September 4, 2012

PC Member, EMPIRE 2012, 20th IEEE International Requirements Engineering Conference (RE 2012), Chicago, USA, September 24-28, 2012

PC Member, Industry Track, 20th IEEE International Requirements Engineering Conference (RE 2012), Chicago, USA, September 25, 2012

PC Member, NFPinDSML 2012: Fourth International Workshop on Non-functional System Properties in Domain Specific Modeling Languages, MODELS 2012, Innsbruck, Austria, October 1, 2012

Fachlicher Leiter User Group RE der Softwareforen, WS 2011/2012, Leipzig, Germany, since November 2011

Fachlicher Leiter User Group RE der Softwareforen, WS 2012/2013, Leipzig, Germany, since November 2012

Mitglied Leitungsgremium, GI Fachgruppe Requirements Engineering, GI FG RE Jahrestagung 2012, Nuremberg, Germany, November 29-30, 2012

Hess, S.:

PC Member, 2nd International Conference on Design, User Experience and Usability, HCI International 2013, Las Vegas, USA, July 21-26, 2013

Jedlitschka, A.:

Program Committee, ESEM 2012, Lund, Sweden, September 20-21, 2012

Program Co-Chair, PROFES 2012, Madrid, Spain, June 13-15, 2012

Kläs, M.:

PC Member, Special session Estimation and Prediction in Software & Systems Engineering (EsPreSSE), 38th EURO-MICRO Conference Software Engineering and Advanced Applications (SEAA), Cesme Izmir, Turkey, September 5-8, 2012

Klaus, A.:

Member Program Committee, The Fourth International Conference on Advances in System Testing and Validation Lifecycle, VALID 2012, Lisbon, Portugal, November 18-23, 2012

Research Institute Liaison Chair, The Fourth International Conference on Advances in System Testing and Validation Lifecycle, VALID 2012, Lisbon, Portugal, November 18-23, 2012

Liggesmeyer, P.

PC Member, Elektronik und Software, CVT Symposium 2012, Kaiserslautern, Germany, March 13-15, 2012

PC Member, Fast Abstracts Session Chairs, COMPSAC 2012, Izmir, Turkey, July 16-20, 2012

PC Member, SAFECOMP 2012, Magdeburg, Germany, September 25, 2012

Knodel, J.:

Co-Organizer, Tutorial Chair, 16th European Conference on Software Maintenance and Reengineering (CSMR), Szeged, Hungary, March 27-30, 2012

PC Member, 16th European Conference on Software Maintenance and Reengineering (CSMR), Szeged, Hungary, March 27-30, 2012

PC Member, Tool Demonstration Track, 16th European Conference on Software Maintenance and Reengineering (CSMR), Szeged, Hungary, March 27-30, 2012

PC Member, Second International Workshop on Variability in Software Architecture (VARSA 2012), Joint 10th Working IEEE / IFIP Conference on Software Architecture (WICSA) & 6th European Conference on Software Architecture (ECSA), Helsinki, Finland, August 20, 2012

PC Member, Tool Demonstration Track, 28th IEEE International Conference on Software Maintenance (ICSM 2012), Riva del Garda, Trento, Italy, September 23-30, 2012

PC Member, 19th Working Conference on Reverse Engineering (WCRE 2012), Kingston, Ontario, Canada, October 15-18, 2012

PC Member, The Seventh International Conference on Software Engineering Advances (ICSEA 2012), Lisbon, Portugal, November 18-23, 2012

Co-Organizer, Tutorial Chair, 17th European Conference on Software Maintenance and Reengineering (CSMR), Pisa, Italy, March 5-8, 2013

PC Member, 17th European Conference on Software Maintenance and Reengineering (CSMR), Pisa, Italy, March 5-8, 2013

PC Member, Tool Demonstration Track, 29th IEEE International Conference on Software Maintenance (ICSM 2013), Eindhoven, The Netherlands, September 22-28, 2013

PC Member, 29th IEEE International Conference on Software Maintenance (ICSM 2013), Eindhoven, The Netherlands, September 22-28, 2013

Luiz, T.:

Chair of Board, Leitstelle und Leitlinien, Dt. Interdisziplinärer Notfallmedizin Kongress, Wiesbaden, Germany, February 10, 2012

Chair of Board, Leitstellen, 27. Notfallmedizinische Jahrestagung, Baden-Baden, Germany, March 16, 2012

Naab, M.:

PC Member, SCARVES, SPLC 2012, Salvador, Brazil, September 02-07, 2012

PC Member, Journal - Information and Software Technology, since 2012

Trapp, Mario:

PC Member, NF-PinDSML2012: Fourth International Workshop on Non-functional System Properties in Domain Specific Modeling Languages, MODELS 2012, Innsbruck, Austria, October 1, 2012

PC Member, International Workshop on Models@ Runtime, Innsbruck, Austria, October 1, 2012

Tagungsleitung, Safetronic 2012, Munich, Germany, November 6-7, 2012

Industry Co-Chair, 4th IFAC Workshop on Dependable Control of Discrete Systems, York, United Kingdom, September 4-6, 2013

PC Member, 32nd SAFECOMP 2013 - The International Conference on Computer Safety, Reliability and Security, Toulouse, France, September 24-27, 2013

Organizer, CARS: 2nd Workshop on Critical Automotive Applications: Robustness & Safety, 32nd SAFECOMP 2013 - The International Conference on Computer Safety, Reliability and Security, Toulouse, France, September 24-27, 2013

Industry Track, MODELS 2013, Miami, USA, September 29 - October 4, 2013

Schwarz, R.:

PC Member, 2012 International Conference on Security Technology, SecTech 2012, Jeju, Korea, November 28-30, 2012

Villela, K.:

Organizer, 2nd International Workshop on Services, Clouds and Alternative Design Strategies for Variant-Rich Software Systems, SPLC 2012, Salvador, Brazil, September 4, 2012

PC Member, First International Workshop on Requirements Engineering Practices On Software Product Line Engineering (Repos 2012), SPLC 2012, Salvador, Brazil, September 4, 2012

PC Member, The 7th International Workshop on Variability Modelling of Software-intensive Systems (VaMoS), Pisa, Italy, January 23-25, 2013

Webel, C.:

Organizer & PC Member, Future Business Software 2012 (FBS'12), 1st International Future Business Software Conference, St. Leon-Rot, Germany, September 25, 2012

Wessner, M.:

PC Member, 4th International Conference on Computer Supported Education (CSEDU 2012), Porto, Portugal, April 16-18, 2012

PC Member, IADIS International Conference e-Learning 2012, Lisbon, Portugal, July 17-20, 2012

PC Member, e-Learning
Fachtagung Informatik (DeLFI
2012), Hagen, September 24-
26, 2012 Germany,

PC Member, World Confer-
ence on E-Learning in Corpo-
rate, Government, Healthcare
& Higher Education (E-Learn
2012), Montréal, Canada
October 9-12, 2012

PC Member, E-Learning Sym-
posium, Potsdam, Germany,
November 17, 2012

PC Member, IADIS Interna-
tional Conference e-Learning
2013, Lisbon, Portugal,
March 13-15, 2013

PC Member, 5th International
Conference on Computer-
Supported Education (CSEDU
2013), Aachen, Germany,
May 6-8, 2013

PC Member, 10th Inter-
national Conference on
Computer-Supported Collab-
orative Learning (CSCL 2013),
Madison, WI, USA, June
15-19, 2013

PC Member, e-Learning
Fachtagung Informatik (DeLFI
2013), Bremen, Germany,
September 8-11, 2013

PC Member, World Confer-
ence on E-Learning in Corpo-
rate, Government, Healthcare
& Higher Education (E-Learn
2013), Las Vegas, USA, Octo-
ber 21-25, 2013

SCIENTIFIC AND TECHNOLOGICAL ADVISORY BOARDS

Dörr, J.:

Spokesperson (& Member), Gesellschaft für Informatik e.V. (GI), Fachgruppe Requirements Engineering, Germany, since 2010

Member, Steering Committee, International Conference on Requirements Engineering: Foundation for Software Quality (REFSQ), since 2011

Member, VDI/VDE GMA Fachausschuss 1.50 Methoden der Steuerungstechnik, since 2008

Göpfert, B.:

Member, STAR-Anwenderbeirat, Munich, Germany, since October 2007

Kemmann, S.:

Member, VDI-Fachausschuss "Qualitätssicherung für Software in der Medizintechnik", since 2010

Klaus, A.:

Member, VDI-Fachausschuss "Qualitätssicherung für Software in der Medizintechnik", since 2009

Liggesmeyer, P.:

Vice-President, Gesellschaft für Informatik e.V. (GI), Bonn, Germany, since 2012

Member, Steering Committee, Gesellschaft für Informatik e.V. (GI), Germany, since 1999

Chair, Special Interest Group "Softwaretechnik", Gesellschaft für Informatik e.V. (GI), Germany, since 1999

Spokesperson (& Member), Fraunhofer-Allianz Embedded Systems, Germany, since 2010

Member, Hochschulrat Hochschule Darmstadt, Darmstadt, Germany, since 2011

Münch, J.:

Member, Committee, Diploma Thesis Awards, DASMA e.V., Germany, since 2005

Rombach, D.:

Chair & Coordinator, ISERN (International Software Engineering Research Networks), since 1996

Member, Advisory Board, Fraunhofer Center Maryland, College Park, USA, since 1998

Member, Advisory Board, Otto A. Wipprecht-Stiftung, Germany, since 1999

Member, Advisory & Expert Group for the Minister President of Rhineland-Palatinate, Germany, since 2002

Chair, Board, SEI Process Achievement Award, USA, since 2009

Chair, Committee, IEEE Harlan D. Mills Award, USA, since 2009

Member, Steering Committee, KIST (Korea Institute of Science and Technology) Europe Forschungsgesellschaft mbH, Korea, since 2006

Member, Scientific Advisory Board, NICTA (National Information and Communications Technologies Australia), Australia, since 2006

Member, Advisory Board, fortiss, Munich, Germany, since 2009

Schwarz, R.:

Founding Member, Committee, International Secure Software Engineering Council (ISSECO), Potsdam, Germany, since 2008

Wessner, M.:

Member, Steering Board, Special Interest Group "E-Learning", Gesellschaft für Informatik (GI), since 2002

PARTICIPATION IN DELEGATIONS

Rombach, D.:

Member, Delegation with Klaus Weichel, Michael Wenk, Werner Weiss, Salvador, Brazil, February 29 - March 12, 2012

Member, Delegation with Michael Wenk, Split, Croatia, May 18-23, 2012

MEMBERSHIPS IN INDUSTRIAL ADVISORY BOARDS

Münch, J.:

Member, Advisory Board, SASQIA / OrgaTech GmbH, Lünen, Germany, since 2006

Member, Advisory Board, ACCEL GmbH, Lünen, Germany, since 2006

Rombach, D.:

Member, Advisory Board, Stiftung der Gasanstalt, Kaiserslautern, Germany, since 2002

Member, Advisory Board, Stadtparkasse Kaiserslautern, Kaiserslautern, Germany, since 2004

Chairman of the Board., 1. FC Kaiserslautern (Professional Soccer Club), Kaiserslautern, Germany, since 2008

Schwarz, R.:

ISSECO, International Secure Software Engineering Council e.V., Potsdam, Germany, since 2012

MEMBERSHIPS IN PROFESSIONAL ASSOCIATIONS**AAL-Allianz**

Access SOS Emergency

ACL – Association for Computational Linguistics

ACM – Association of Computing Machinery

AGBC – American-German Business Club Deutschland e.V.

AMS – American Mathematical Society

ASQF e.V. – Arbeitskreis Software-Qualität in Franken

BV-Päd. – Bundesverband der Diplom-Pädagoginnen und Diplom-Pädagogen e.V.

CAST e.V. – Competence Center for Applied Security Technology

CVC – Commercial Vehicle Cluster

DASMA – German Software Metrics and Effort Estimation Association

DGI – Deutsche Gesellschaft für Informationswissenschaft und Informationspraxis e.V.

DIN – Deutsches Institut für Normung

Förderverein Informatik TU KL/FIT

Fraunhofer Academy

Freundeskreis TU KL

gc-UPA – German Chapter of the Usability Professionals' Association

GDM – Gesellschaft für Didaktik der Mathematik

GFal – Gesellschaft zur Förderung angewandter Informatik e.V.

GFFT – Gemeinnützige Gesellschaft zur Förderung des Forschungstransfers e.V.

GI – Gesellschaft für Informatik

idw – Informationsdienst Wissenschaft

IEEE – Institute of Electrical and Electronic Engineers

IMA – Institute of Mathematics and its Application

ISQI (Weit e.V.)

ISSECO – International Secure Software Engineering Council

IuK – Fraunhofer Information and Communication Group

LAP – Liberty Alliance Project

MedTech Pharma

OMG – Object Management Group

Open BC – Open Business Club

SafeTRANS – Safety in Transportation Systems

Science Alliance Kaiserslautern

Softwareforen Leipzig GmbH

STI – Software Technologie Initiative e.V.

Tekom – Fachverband für technische Kommunikation und Dokumentation

VDR – Verband Deutsches Reisemanagement e.V.

XING AG

KEYNOTES**Kemman, S.:**

"All you need is a 'handful' of safety", CBSEC 2012, Campinas, Brazil, May 24, 2012

Liggemeyer, P.:

"Sichere Systeme - Möglichkeiten und Grenzen", 20. Technologie- und InnovationsFORUM, Kaiserslautern, Germany, March 21, 2012

"Verlässliche Embedded Systems: Modellieren, Testen, Analysieren", 10. Anwenderkonferenz Softwarequalität und Test (ASQT 2012), Klagenfurt, Austria, September 7, 2012

"Von der Sicherheitsanalyse zum Safety Engineering: Aktuelle Forschungsschwerpunkte", ASE-Workshop (Automotive Software Engineering) 2012, Braunschweig, Germany, September 17, 2012

Rombach, D.:

"Schlaganfall - Technische Hilfsmittel der Zukunft", 11. Südwestdeutscher Schlaganfalltag, Westpfalz-Klinikum, Kaiserslautern, Germany, March 3, 2012

"Applied Research in Informatics with Industry: The Fraunhofer Model", Seminar at Software Engineering Group, Free University of Bolzano, Bolzano, Italy, April 11, 2012

"Empirical Models: Towards a Science of Software Engineering", EASE 2012, Ciudad Real, Spain, May 14, 2012

"Improving Patient Safety and Risk Management through Software & Ambient Technology", Colloquium, Technische Universität Clausthal, Clausthal, Germany, December 6, 2012

Trapp, Marcus:

"Innovation through User Experience", Industrieseminar - Cag Gemini, Bad Hersfeld, Germany, August 24, 2012

Trapp, Mario:

"Messen und Bewerten funktionaler Sicherheit - Herausforderungen und Lösungsansätze", Metrikon, Stuttgart, Germany, November 9, 2012

Van Lengen, R.:

"Process Analysis and Optimization in Emergency Medicine", ICSSP 2012, Zurich, Switzerland, June 2, 2012

PRESENTATIONS

Adam, S.:

“Wenn Prozesse laufen lernen...Requirements Engineering bei der Einführung von Geschäftsprozessmanagement”, Conference Presentation, ReConf 2012, Hood Group, Munich, Germany, March 13, 2012

“Providing Software Product Line Knowledge to Requirements Engineers - A Template for Elicitation Instructions”, Conference Presentation, ReFSQ-Konferenz 2012, Essen, Germany, March 19-22, 2012

“Focusing on the “Right” Requirements by Considering Information Needs, Priorities, and Constraints”, Workshop Presentation, REEW Workshop 2012, Essen, Germany, March 19, 2012

“BPMN vs. EPK & Co.... oder auf was es wirklich ankommt”, Talk, VBPM/ERP, St. Augustin, Germany, May 15, 2012

“A Conceptual Foundation of Requirements Engineering for Business Process Applications”, Conference Presentation, BPMDS Conference, Gdansk, Poland, June 25, 2012

“Wenn Prozesse laufen lernen - Requirements Engineering bei der Einführung von Geschäftsprozessmanagement in Unternehmen” Invited Talk, W-JAX-Vortrag, Munich, Germany, November 6, 2012

Becker, M.:

“Den Varianten-Dschungel durchforsten und kultivieren”, Presentation at conference, Embedded Software Engineering Kongress, MicroConsult Microelectronics Consulting & Training GmbH, Dubai, United Arab Emirates, December 7, 2012

Adler, R.:

“Model-based Development of a Safety Concept”, Presentation, 11th International Probabilistic Safety Assessment and Management Conference and the Annual European Safety and Reliability Conference 2012, Helsinki, Finland, June 26, 2012

Dörr, J.:

“Kritische Qualitätsanforderungen vollständig spezifizieren? Und es geht doch...”, Talk, Softwareforen - 4. Arbeitstreffen der User Group “Requirements Engineering”, Softwareforen Leipzig GmbH, Leipzig, Germany, March 8, 2012

“TwinPeaks Workshop”, Workshop Presentation, RE 2012, IEEE, Chicago, USA, September 25, 2012

“Empiricism in Requirements Engineering”, Panel Presentation, EMPIRE Workshop - RE 2012, IEEE, Chicago, USA, September 25, 2012

“EMPIRE Workshop”, Workshop Presentation, RE 2012, IEEE, Chicago, USA, September 25, 2012

“What you need is what you get! The Vision of View-based Requirements Specifications”, Conference Presentation, RE 2012, IEEE, Chicago, USA, September 27, 2012

“Requirements Engineering for Requirements Engineering - The need for understanding our stakeholders’ information needs”, Workshop Presentation, Workshop Requirements Management - Novel Perspectives and Challenges, Universität des Saarlandes, Schloss Dagstuhl, Leibniz-Center for Informatics, Wadern, Germany, October 30, 2012

Göpfert, B.:

“Das einzig Beständige ist der Wandel: 15 Jahre Fraunhofer IESE Library and Information Services”, Presentation, Study Course “Information Management”, Hochschule Hannover - University of Applied Sciences and Arts, Hanover, Germany, December 3, 2012

Gross, A.:

“Gestaltung Intuitiver Benutzungsschnittstellen - Eine RE-Methode zur Erhebung und Spezifikation mentaler Benutzermodelle”, Conference Presentation, ReConf 2012, Hood Group, Munich, Germany, March 12, 2012

“What do you expect from Requirements Specifications? An Empirical Investigation of Information Needs”, Poster Presentation, REFSQ 2012, Paluno, Essen, Germany, March 21, 2012

Hess, S.:

“‘Sprint Minus One’ - Agiles RE zur Konzeption Mobiler Business Apps”, Conference Paper Presentation, ReConf 2012, Hood Group, Munich, Germany, March 12, 2012

“WhatsApp - One App to Rule Them All”, Conference Paper Presentation, CHI Conference, SigCHI, Austin, USA, May 5, 2012

“Does the iPad add Value to Business Environments?”, Workshop Presentation, CHI Conference - Workshop on Wow-Products, SigCHI, Austin, USA, May 7, 2012

“Do Apps need Architecture?”, Talk, BITKOM Arbeitskreis Apps, Mobile & Co., BITKOM, Munich, Germany, June 25, 2012

“Lasst die Nutzer reden! Wie Alltagserfahrungen in die Gestaltung intuitiv bedienbarer Software überführt werden können”, Tutorial, Workshop IBIS (World Usability Day), Mannheim, Germany, August 11, 2012

“mConcAppt Methode - UX und Interaktionsdesign für mobile Business Apps”, Tutorial, Mensch & Computer, German UPA e.V., Konstanz, Germany, September 8, 2012

“Standardizing Model-Based In-Vehicle Infotainment Development in the German Automotive Industry”, Conference Paper Presentation, Automotive UI Konferenz, Automotive UI Conference Series, Portsmouth, USA, October 18, 2012

“automotiveHMI - Heading towards a Development Process for Future Infotainment Systems”, Conference Presentation, Communication World Vortrag, Messe München International, Munich, Germany, November 6, 2012

“Die IBIS-Methode. Eine RE-Methode zur Entwicklung intuitiver Nutzungsschnittstellen”, Talk, GI-Fachgruppentreffen, Gesellschaft für Informatik, Nuremberg, Germany, November 30, 2012

“mConcAppt - Methode zur Konzeption von mobilen Business Apps”, Talk, GI-Fachgruppentreffen, Gesellschaft für Informatik, Nuremberg, Germany, November 30, 2012

“Auto 2.0 - Mehr als nur Telefonieren beim Fahren”, Conference Presentation, Useware Konferenz, VDI, Kaiserslautern, Germany, December 4, 2012

Kemmann, S.:

“The ‘why’ and ‘how’ of Software Safety Analysis”, ICMC/USP Workshop São Carlos, Brazil, May 29, 2012

“GOBI and OASIS - A concept and its realization for model-based situation descriptions compliant to ISO 26262”, Presentation, 11th International Probabilistic Safety Assessment and Management Conference and the Annual European Safety and Reliability Conference 2012, Helsinki, Finland, June 26, 2012

“ARID - A model-based risk analysis approach”, Presentation, 11th International Probabilistic Safety Assessment and Management Conference and the Annual European Safety and Reliability Conference 2012, Helsinki, Finland, June 26, 2012

“Risikomanagement, Gebrauchstauglichkeit, System- und Softwareentwicklung. Das Ziehen an einem Strang ... doch die Richtung ist meist offen”, MedConf 2013, Munich, Germany, September 27, 2012

“Modelbasierte Sicherheitsanalysen im Förderprojekte performance”, Automotive - Safety & Security 2012, Karlsruhe, Germany, November 15, 2012

Kläs, M.:

“Aligning Technology Evaluation in Large-Scale Research Projects by GQM+Strategies”, Workshop Presentation, 20th International Software Engineering Research Network Annual Meeting, ISERN, Lund, Sweden, September 18, 2012

Kuhn, T.:

“Virtual Engineering”, Presentation at Conference, Bits&Chips Symposium, Bits&Chips, s’Hertogenbosch, The Netherlands, November 8, 2012

“INProVE”, Invited Presentation, Airbus research workshop, Airbus, Hamburg, Germany, October 26, 2012

Lampasona, C.:

“Software Quality Modeling Experiences at an Oil Company”, Conference Paper, ESEM2012, Lund University, Lund, Sweden, September 19, 2012

“Seamless Integration of Order Processing in MS Outlook Using SmartOffice: An Empirical Evaluation”, Conference Paper, ESEM2012, Lund University, Lund, Sweden, September 19, 2012

„Application Scenarios and Guidelines for Quality Model Adaptation”, Conference Paper, Metrikon 2012, DASMA, Stuttgart, Germany, November 8, 2012

Landmann, D.:

“Anforderungs- und Systemmodellierung in großen Projekten - Projektbericht zur Kampfschiffklasse MKS180”, Presentation at Conference, Embedded Software Engineering Kongress, MicroConsult Microelectronics Consulting & Training GmbH, Sindelfingen, Germany, October 6, 2012

“Systems & Requirements Engineering für das Mehrzweckkampfschiff 180”, Invited Presentation, DWT-Sektion Nordsee: 14. Symposium über Verbindungen, Deutsche Gesellschaft für Wehrtechnik, Wilhelmshaven, Germany, June 26-27, 2012

“Requirements Engineering Tools”, Invited Presentation, Fortbildungskonzepte für Systems und Requirements Engineering im neuen Ausrüstungs- und Nutzungs-

prozess der Bundeswehr, Bundesakademie für Wehrverwaltung und Wehrtechnik, Mannheim, Germany, December 7, 2012

Luiz, T.:

“Elektronischer Zentraler Landesweiter Behandlungskapazitätsnachweis Rheinland-Pfalz”, Invited Lecture, Curriculum Notfallmedizin, Kaiserslautern, Germany, January 26, 2012

“Status quo und Erwartungen der Mitarbeiter an die zukünftige Einsatzdokumentation im Rettungsdienst”, Conference Talk, Wissenschaftliche Arbeitstage Notfallmedizin der Deutschen Gesellschaft für Anästhesiologie und Intensivmedizin, Kiel, Germany, February 5, 2012

“Notarztmangel - Heraus aus der Krise”, Invited Lecture, Deutscher Interdisziplinärer Notfallmedizin Kongress, Deutsche Interdisziplinäre Vereinigung für Intensiv- und Notfallmedizin, Wiesbaden, Germany, February 10, 2012

“Elektronischer Zentraler Landesweiter Behandlungskapazitätsnachweis Rheinland-Pfalz”, Invited Lecture, Mainzer Notfallsymposium, Universitätsklinikum Mainz, Mainz, Germany, February 24, 2012

“Strukturierte Notrufabfragesysteme in Rettungsleitstellen”, Invited Lecture, Baden-Badener Gespräche, Arbeitsgemeinschaft Südwestdeutscher Notärzte, Baden-Baden, Germany, March 15, 2012

- “Der neue zentrale landesweite Behandlungskapazitätsnachweis Rheinland-Pfalz - Implikationen für den Notarzt”, Invited Lecture, Frühjahrstagung der Verwaltungsdirektoren der Krankenhäuser Rheinland-Pfalz, Verband der Verwaltungsdirektoren der Krankenhäuser Rheinland-Pfalz, Kaiserslautern, Germany, March 22, 2012
- “Optimierung der Zuweisung von Notfallpatienten mit zeitkritischen Erkrankungen mittels eines webbasierten landesweiten elektronischen Behandlungskapazitätsnachweises (ZLB)”, Poster Presentation, Deutscher Anästhesie Congress, Deutsche Gesellschaft für Anästhesiologie und Intensivmedizin, Leipzig, Germany, May 5, 2012
- “Auf dem Weg ins digitale Zeitalter? Gegenwärtiger Stand und Erwartungen der Mitarbeiter an die zukünftige Einsatzdokumentation im rheinland-pfälzischen Rettungsdienst”, Poster Presentation, Deutscher Anästhesie Congress, Deutsche Gesellschaft für Anästhesiologie und Intensivmedizin, Leipzig, Germany, May 6, 2012
- “Ergebnisse aktueller notfallmedizinischer Studien und Projekte mit Bezug zur Luftrettung”, Invited Lecture, Tagung des Wissenschaftlichen Beirats der Stiftung Luftrettung der Deutschen Rettungsflugwacht, Deutsche Rettungsflugwacht, Regensburg, Germany, May 11, 2012
- “5 Jahre Zentraler Innerklinischer Notfallkoordinator”, Invited Lecture, Curriculum Notfallmedizin, Westpfalz-Klinikum GmbH, Kaiserslautern, August 30, 2012
- “Notärztliche Versorgung in Rheinland-Pfalz: Fakten und Fiktion”, Invited Lecture, 14. Hauptstadtkongress 2012 der DGAI für Anästhesiologie und Intensivtherapie, Deutsche Gesellschaft für Anästhesiologie und Intensivmedizin, Berlin, Germany, September 14, 2012
- “‘Alles nur Spielzeug’? Informationstechnologie im Rettungsdienst. Qualitätssicherung durch zentralen Bettenachweis”, Invited Lecture, 12. DRK Rettungsdienstsymposium, DRK Landesverband Hessen, Hohenroda, Germany, November 15, 2012
- “eZINK - Rückblick auf 5 Jahre Zentraler Innerklinischer Notfallkoordinator”, Invited Lecture, 17. Innovationstag, Westpfalz-Klinikum GmbH, Kaiserslautern, Germany, November 17, 2012
- “Evaluation Zentraler Notaufnahmen von Kliniken”, Oral presentation, Symposium Medizin, Wissenschaft, Technologie. Zentrum für Gesundheitswissenschaften Kaiserslautern, Science Alliance, Kaiserslautern, Germany, November 19, 2012
- Naab, M.:**
 “View-Based Architecture Documentation”, Invited Talk, Airline Solutions Technology Days, Lufthansa Systems, Seeheim, Germany, April 12, 2012
- “Architectural Flexibility in a Software-System’s Life-Cycle: Systematic Construction and Exploitation of Flexibility”, Conference Paper Presentation, QoSA 2012, Bertinoro, Italy, June 26, 2012
- “Zukunftssichere Software Systeme mit Architekturbeurteilung: Wann, Wie und Wieviel?”, Tutorial, Informatik 2012, Gesellschaft für Informatik, Braunschweig, Germany, September 19
- “Architektur - für wen, was, wann, und wieviel?”, Invited Talk, Symposium Software Architektur, Technische Akademie Esslingen, Ostfildern, Germany, September 27, 2012
- Ochs, M.:**
 “Governance, Risk & Compliance in der IT - Der heiße Stuhl”, Invited Talk, Softwareforen - Jahrestagung - IT-Trendsw, Innovationen und Ergebnisse, Softwareforen Leipzig GmbH, Leipzig, Germany, January 31, 2012
- “CMMI vs. ITIL: Freund oder Feind?”, Invited Talk, Softwareforen - 3. Arbeitstreffen Mapping zwischen IT-Management-Frameworks und Governance, Risk & Compliance - Umsetzung und Zusammenspiel in der Praxis, Softwareforen Leipzig GmbH, Leipzig, Germany, September 25, 2012
- Riegel N.:**
 “Wenn Prozesse laufen lernen...Requirements Engineering bei der Einführung von Geschäftsprozessmanagement”, Conference Paper Presentation, ReConf 2012, Hood Group, Munich, Germany, March 13, 2012
- “Tackling Prioritization in Business-Process-Driven Software Development”, Workshop Presentation, RePriCo 2012, Paluno, Essen, Germany, March 19, 2012
- “BPMN vs. EPK & Co...oder auf was es wirklich ankommt”, Talk, Vortrag BPM/ERP, St. Augustin, Germany, May 15, 2012
- “Model-Based Prioritization in Business-Process-Driven Software Development”, Doctoral Symposium Paper, RE’12 Conference, IEEE, Chicago, USA, September 24, 2012
- “Wenn Prozesse laufen lernen - Requirements Engineering bei der Einführung von Geschäftsprozessmanagement in Unternehmen”, Invited Talk, W-JAX-Vortrag, Munich, Germany, November 6, 2012
- “Modellbasierte Priorisierung in geschäftsprozessgetriebener Softwareentwicklung”, Talk, GI-Fachgruppentreffen, Gesellschaft für Informatik, Nuremberg, Germany, November 19, 2012

Rombach, D.:

“Schlaganfall - Technische Hilfsmittel der Zukunft”, Invited Presentation, 11. Südwestdeutscher Schlaganfalltag, Westpfalz-Klinikum Kaiserslautern, Kaiserslautern, Germany, March 03, 2012

“Applied Research in Informatics with Industry: The Fraunhofer Model”, Seminar at Software Engineering Group, Free University of Bolzano, Bolzano, Italy, April 11, 2012

“High-Tech-Produkt “Fahrersitz” - Recaro”, Presentation, Vorstellung der neuen Recaro Nutzfahrzeugsitzserie, RECARO home GmbH, Kaiserslautern, Germany, November 29, 2012

“Improving Patient Safety and Risk Management through Software & Ambient Technology”, Presentation, Colloquium, Technische Universität Clausthal, Clausthal-Zellerfeld, Germany, December 6, 2012

Rost, D.:

“Generation of Task-Specific Architecture Documentation for Developers”, Conference Paper, WCOP 2012 - International Doctoral Symposium on Components and Architecture, ACM - SigSoft, Bertinoro, Italy, June 25, 2012

“Architecture Engagement Purposes: A Framework for Planning “Just Enough”-Architecting in Software Engineering”, Conference Paper Presentation, WICSA 2012, IEEE/IFIP, Helsinki, Finland, August 23, 2012

Rudolph, M.:

“Access Control und dann? – Wie Datennutzungskontrolle Unternehmensgeheimnisse effektiv schützen kann”, Talk, Conect Informunity, Conect, Vienna, Austria, February 20, 2012

“A Critical Survey of Security Indicator Approaches”, Conference Presentation, ARES Conference, SBA Research, Prague, Czech Republic, August 23, 2012

“Data Usage Control”, Invited Lecture, Hochschule Mannheim, Mannheim, Germany, December 18, 2012

Trapp, Marcus:

“User Experience & Agile Entwicklung - Freund oder Feind?”, Talk, Softwareforen - 3. Arbeitstreffen der User Group “Usability Engineering”, Softwareforen Leipzig GmbH, Leipzig, Germany, March 28, 2012

“GoMobile”, Talk, Industrieseminar, BASF, Bad Dürkheim, Germany, June 26, 2012

“Power-on User Experience”, Talk, World Usability Day 2012, German UPA e.V., Mannheim, Germany, August 11, 2012

“Technologietransfer durch Entwicklungspartnerschaften - Realisierung eines Leitstandes für den Digitalen Mailroom”, Talk, inco insurance 2012, Insiders Technologies, Königswinter, Germany, September 17, 2012

Trapp, Mario:

“Trends in Software Engineering”, Invited Presentation, Plattform Softwareentwicklung, FH Dornbirn, Dornbirn, Austria, February 9, 2012

“Five Rules for Ensuring Functional Safety”, Invited Presentation, Tage des Hybrids, fka/ika, Aachen, Germany, May 23, 2012

“Modulare Sicherheit - Sicherheit im Baukastensystem?”, Invited Presentation, Embedded Conference, Windriver, Stuttgart, Germany, July 3, 2012

“A Safety Roadmap to Cyber Physical Systems”, Talk, AK CPS, BITCOM, Berlin, Germany, September 12, 2012

“Current Trends in Medical Equipment Software Development”, Invited Presentation, Accenture Roundtable, Accenture, Erlangen, Germany, November 14, 2012

“The Future of Safety Engineering”, Invited Tutorial, Safety@Siemens, Siemens, Munich, Germany, November 28-29, 2012

Webel, C.:

“Challenges for Engineering Emergent Business Applications”, Introductory speech, FBS 2012, Software-Cluster, St. Leon-Rot, Germany, September 25, 2012

Wessner, M.:

“e-Learning zwischen Alpen und Küste - eine Analyse der DeLFI-Community”, Conference Paper, DeLFI 2012, FernUni Hagen, Hagen, Germany, September 24-26, 2012

“ICE-WISH: Einsatz intelligenter IT zum Energie- und Wassersparen im europäischen sozialen Wohnungsbau”, Invited Talk, Netzwerk-Treffen Smart Grids, Mainz, Germany, December 11, 2012

Zehler, T.:

“Agile Software-Entwicklung im Spannungsfeld zwischen Reifegradmodellen und funktionaler Sicherheit”, Workshop Presentation, IBS-Workshop “Agile Software-Entwicklung”, Stiftung Internationales Informatik- und Begegnungszentrum Sachsen, Laubusch, Germany, October 2, 2012

Zimmer, B.:

“Safety-Focused Deployment Optimization in Open Integrated Architectures” 31st International Conference on Computer Safety, Reliability, and Security (SAFECOMP) Magdeburg, Germany, September 28, 2012

SCIENTIFIC CONTRIBUTIONS²

BOOKS

Münc, Jürgen; Armbrust, Ove; **Kowalczyk, Martin;** Soto, Martin:
Software Process Definition and Management. Berlin: Springer-Verlag, 2012 (The Fraunhofer IESE Series on Software and Systems Engineering)
ISBN 978-3-642-24290-8
DOI <http://dx.doi.org/10.1007/978-3-642-24291-5>

Knaup-Gregori, Petra; Schöpe, Lothar; Demski, Hans; Ganzinger, Matthias; Hannig, Rüdiger; Helmer, Axel; Janowski, Anna; Kraft, Andreas; Kolly, Laurent; Kröger, Reinhold; Plischke, Maik; Schäfer, Jan; Schöchlin, Jürgen; Spitalewsky, Katharina; Soltani, Nazli; Stiller, Carsten; **Storf, Holger;** Thoss, Marcus; Ulrich, Siegfried:
Von eingebetteten zu soziotechnischen Systemen. Potenzial und Forschungsbedarf auf dem Gebiet der IT im AAL-Umfeld.
Berlin: VDE-VERLAG, 2012
ISBN 978-3-8007-3420-7

ARTICLES IN BOOKS

Bagnato, Alessandra; Raiteri, Fabio; **Jung, Christian;** **Elberzhager, Frank:**
Creating and Applying Security Goal Indicator Trees in an Industrial Environment.
In: Gupta, Manish (Ed.); Walp, John (Ed.); Sharman, Raj (Ed.): Threats, Countermeasures, and Advances in Applied Information Security. Hershey : IGI Global, 2012, 266-280.
DOI <http://dx.doi.org/10.4018/978-1-4666-0978-5.ch014>

Höfig, Kai; Trapp, Mario; Zimmer, Bastian; Liggesmeyer, Peter:
Modeling Quality Aspects: Safety.
In: Pohl, Klaus (Ed.); Höningner, Harald (Ed.); Achatz, Reinhold (Ed.); Broy, Manfred (Ed.): Model-Based Engineering of Embedded Systems. The SPES 2020 Methodology. Berlin: Springer-Verlag, 2012, 107-118.
DOI http://dx.doi.org/10.1007/978-3-642-34614-9_8

Jedlitschka, Andreas; Jung, Jessica; Lampasona, Costanza:
Evaluation Summary.
In: Pohl, Klaus (Ed.); Höningner, Harald (Ed.); Achatz, Reinhold (Ed.); Broy, Manfred (Ed.): Model-Based Engineering of Embedded Systems. The SPES 2020 Methodology. Berlin: Springer-Verlag, 2012, 231-239.
DOI http://dx.doi.org/10.1007/978-3-642-34614-9_16

Jedlitschka, Andreas; Jung, Jessica; Lampasona, Costanza:
Evaluation Summary.
In: Pohl, Klaus (Ed.); Höningner, Harald (Ed.); Achatz, Reinhold (Ed.); Broy, Manfred (Ed.): Model-Based Engineering of Embedded Systems. The SPES 2020 Methodology. Berlin: Springer-Verlag, 2012, 231-239.
DOI http://dx.doi.org/10.1007/978-3-642-34614-9_16

Jedlitschka, Andreas; Löwen, Ulrich:
Overview of the SPES Evaluation Strategy.
In: Pohl, Klaus (Ed.); Höningner, Harald (Ed.); Achatz, Reinhold (Ed.); Broy, Manfred (Ed.): Model-Based Engineering of Embedded Systems. The SPES 2020 Methodology. Berlin: Springer-Verlag, 2012, 131-135.
DOI http://dx.doi.org/10.1007/978-3-642-34614-9_10

Luiz, Thomas:
Sicherheit bei Großveranstaltungen: Vorbereitung und Durchführung aus Sicht des Notfallmediziners.
In: Hoffmann, Reinhard (Hrsg.); Schweigkofler, Uwe (Hrsg.); Thomann, Klaus-Dieter (Hrsg.): Katastrophen und Großereignisse bewältigen: Gefahren erkennen und abwehren. Rettung und medizinische Notfallversorgung, Versicherung und Entschädigung. Frankfurt: Referenz Verlag, 2012, 45-77.

Nass, Claudia; Adam, Sebastian; Doerr, Joerg; Trapp, Marcus:
Balancing User and Business Goals in Software Development to Generate Positive User Experience.
In: Zacarias, Marielba (Ed.); Valente de Oliveira, José (Ed.): Human-Computer Interaction: The Agency Perspective. Berlin: Springer-Verlag, 2012, 29-53. (Studies in Computational Intelligence Vol. 396).
DOI http://dx.doi.org/10.1007/978-3-642-25691-2_2

Steinbach-Nordmann, Silke; Staudt, Michael:
Lernend Altern - LEA: Technologiestützte Kurse an der Volkshochschule Kaiserslautern.
In: Ackermann, Karl-Ernst (Hrsg.); Burtscher, Reinhard (Hrsg.); Ditschek, Eduard Jan (Hrsg.); Schlummer, Werner (Hrsg.): Inklusive Erwachsenenbildung : Kooperationen zwischen Einrichtungen der Erwachsenenbildung und der Behindertenhilfe. Berlin: GEB, 2012, 109-113. (Die schräge Reihe 10).

2) Names of CESE and Fraunhofer IESE members appear in bold.

ARTICLES IN JOURNALS

Adam, Sebastian; Riegel, Norman; Doerr, Joerg; Uenal, Oezguer; Kerkow, Daniel:
From Business Processes to Software Services and Vice Versa - An Improved Transition through Service-oriented Requirements Engineering. In: *Journal of Software: Evolution and Process*. 24 (2012), 3, 237-258; First Published Online: 29 SEP 2011. DOI <http://dx.doi.org/10.1002/smr.558>

Duszynski, Slawomir; Becker, Martin; Kalmar, Ralf:
Variantenanalyse - Wiederverwendungspotenzial auf Basis einer Quellcodeanalyse. In: *ATZ elektronik*. 7 (2012), 6, 440-445.

Elberzhager, Frank; Münch, Jürgen; Rombach, H. Dieter; Freimut, Bernd:
Integrating inspection and test processes based on context-specific assumptions. In: *Journal of Software: Evolution and Process*. (2012), Published Online: 30 AUG 2012. DOI <http://dx.doi.org/10.1002/smr.1569>

Elberzhager, Frank; Münch, Jürgen; Ngoc Nha, Vi Tran:
A Systematic Mapping Study on the Combination of Static and Dynamic Quality Assurance Techniques. In: *Information and Software Technology*. 54 (2012), 1, 1-15; First Published Online: 16 Jun 2011. DOI <http://dx.doi.org/10.1016/j.infsof.2011.06.003>

Elberzhager, Frank; Rosbach, Alla; Münch, Jürgen; Eschbach, Robert:
Reducing test effort: A systematic mapping study on existing approaches. In: *Information and Software Technology*. 54 (2012), 10, 1092-1106. DOI <http://dx.doi.org/10.1016/j.infsof.2012.04.007>

Groß, Anne; Hess, Steffen:
Was erwarten Usability Experten von Anforderungsdokumenten? In: *i-com. Zeitschrift für interaktive und kooperative Medien*. 11 (2012), 2, 50-54. DOI <http://dx.doi.org/10.1524/icom.2012.0026>

Herrmann, Andrea; Daneva, Maya; **Doerr, Joerg;** Schneider, Kurt:
2nd International Workshop on Creativity in Requirements Engineering - CreaRE 2012. In: *ACM SIGSOFT Software Engineering Notes*. 37 (2012), 4, 30-31. DOI <http://dx.doi.org/10.1145/2237796.2237816>

Hess, Anne; Rombach, H. Dieter; Carbon, Ralf; Hoeh, Michael; Bartolein, Murphy, Daniel F.:
The Role of Collaborative Capstone Projects - Experiences from Education, Research and Industry. In: *International Journal of Engineering Education (Special Issue on Impact of Collaboration between Academia and Industry on Engineering Education)*. Accepted for publication in 2013.

Jeswein, Thomas; Olbrich, Steffen; Bednorz, Michael:
Der P23R: Herausforderungen in der technischen Umsetzung. In: *eGovernment Review*. 5 (2012), 10, 30-31.

Kalmar, Ralf; Knodel, Jens:
Der LKW auf der Datenautobahn. In: *Internationales Verkehrswesen. Transport and Mobility Management*. 64 (2012), 6, 52-54.

Klaus, Alexander:
Stakeholder-orientierter Software Test für Geschäftsanwendungen. In: *Softwaretechnik-Trends*. 32 (2012), 1, 8-9.

Knodel, Jens; Schneider, Daniel:
Offene Software-Architekturen für das Auto der Zukunft. In: *ATZ elektronik*. 7 (2012), 5, 386-390.

Lamersdorf, Ansgar; **Münch, Jürgen;** Fernández-del Viso Torre, Alicia; Sánchez, Carlos Rebate; Heinz, Markus; **Rombach, H. Dieter:**
A rule-based model for customized risk identification and evaluation of task assignment alternatives in distributed software development projects. In: *Journal of Software Maintenance and Evolution Research and Practice*. 24 (2012), 6, 661-675; First Published Online: 23 Nov 2011. DOI <http://dx.doi.org/10.1002/smr.576>

Liggemeyer, Peter:
Die Vorstandskolumne. Die Informatik und die Anderen. In: *Informatik Spektrum*. 35 (2012), 2, 150-151. DOI <http://dx.doi.org/10.1007/s00287-012-0606-7>

Liggemeyer, Peter:
Die Vorstandsperspektive. Schreiben! In: *Informatik Spektrum*. 35 (2012), 5, 329-330. DOI <http://dx.doi.org/10.1007/s00287-012-0646-z>

Nakagawa, Elisa Yumi; **Antonino, Pablo; Becker, Martin;** Maldonado, José Carlos; **Storf, Holger; Vilela, Karina; Rombach, H. Dieter:**
Relevance and perspectives of AAL in Brazil. In: *The Journal of Systems and Software*. (2012), Published Online: 18 October 2012, 12 S. DOI <http://dx.doi.org/10.1016/j.jss.2012.10.013>

Trapp, Mario:
Funktionale Sicherheit in der Automobilindustrie. In: *HANSER Automotive electronics + systems*. 11 (2012), 11, S. 3.

Weitzel, Balthasar:
Towards Transparent Architectural Decisions for Software Deployment. In: *Softwaretechnik-Trends*. 32 (2012), 2, 21-22.

CONTRIBUTIONS TO CONFERENCE PROCEEDINGS

Adam, Sebastian:

Providing Software Product Line Knowledge to Requirements Engineers - A Template for Elicitation Instructions. In: Regnell, Björn (Ed.); Damian, Daniela (Ed.): Requirements Engineering: Foundation for Software Quality. 18th International Working Conference, REFSQ 2012 - Proceedings. Berlin: Springer-Verlag, 2012, 147-164. (Lecture Notes in Computer Science 7195). DOI http://dx.doi.org/10.1007/978-3-642-28714-5_13

Adam, Sebastian; Riegel, Norman; Groß, Anne: Focusing on the "Right" Requirements by Considering Information Needs, Priorities, and Constraints. In: Berntsson Svensson, Richard (Ed.); Berry, Daniel (Ed.); Daneva, Maya (Ed.); **Doerr, Joerg (Ed.);** Fricker, Samuel (Ed.); Herrmann, Andrea (Ed.); Herzwurm, Georg (Ed.); Kauppinen, Marjo (Ed.); Madhavji, Nazim H. (Ed.); Mahaux, Martin (Ed.); Paech, Barbara (Ed.); Penzenstadler, Birgit (Ed.); Pietsch, Wolfram (Ed.); Salinesi, Camille (Ed.); Schneider, Kurt (Ed.); Seyff, Norbert (Ed.); Weerd, Inge van de (Ed.); Universität Duisburg-Essen: 18th International Working

Conference on Requirements Engineering: Foundation for Software Quality. Proceedings of the Workshops RE4SuSy, REEW, CreaRE, RePriCo, IWSPM and the Conference Related Empirical Study, Empirical Fair and Doctoral Symposium. 2012, 68-74. (ICB Research Report 52).

Burgos de Oliveira, Thiago Henrique; Becker, Martin;

Nakagawa, Elisa Yumi: Supporting the Analysis of Bug Prevalence in Software Product Lines with Product Genealogy. In: Schwanninger, Christa (Ed.); Benavides, David (Ed.); Santos, Andre (Ed.); Alves, Vander (Ed.); Almeida, Eduardo Santana (Ed.); Association for Computing Machinery (ACM): 16th International Software Product Line Conference, SPLC 2012. Volume 1 - Proceedings. New York: ACM Press, 2012, 181-185. DOI <http://dx.doi.org/10.1145/2362536.2362561>

Duszynski, Slawomir; Becker, Martin:

Recovering Variability Information from the Source Code of Similar Software Products. In: IEEE Computer Society: 2012 Third International Workshop on Product Line Approaches in Software Engineering (PLEASE) - Proceedings. 2012, 37-40. DOI <http://dx.doi.org/10.1109/PLEASE.2012.6229768>

Tenev, Vasil; Duszynski, Slawomir:

Applying Bioinformatics in the Analysis of Software Variants. In: IEEE Computer Society: 2012 20th IEEE International Conference on Program Comprehension (ICPC) - Proceedings. 2012, 259-260. DOI <http://dx.doi.org/10.1109/ICPC.2012.6240499>

Elberzhager, Frank; Bauer, Thomas:

From Assumptions to Context-specific Knowledge in the Area of Combined Static and Dynamic Quality Assurance. In: Cortellessa, Vittorio (Ed.); Muccini, Henry (Ed.); Demirors, Onur (Ed.); IEEE Computer Society: EURO-MICRO 2012. Proceedings of the 38th EUROMICRO Conference on Software Engineering and Advanced Applications. Los Alamitos: IEEE Computer Society, 2012, 298-301. DOI <http://dx.doi.org/10.1109/SEAA.2012.29>

Elberzhager, Frank; Kremer, Stephan; Münch, Jürgen; Assmann, Danilo:

Guiding Testing Activities by Predicting Defect-prone Parts Using Product and Inspection Metrics. In: Cortellessa, Vittorio (Ed.); Muccini, Henry (Ed.); Demirors, Onur (Ed.); IEEE Computer Society: EURO-MICRO 2012. Proceedings of the 38th EUROMICRO Conference on Software Engineering and Advanced Applications.

Los Alamitos: IEEE Computer Society, 2012, 406-413. DOI <http://dx.doi.org/10.1109/SEAA.2012.30>

Elberzhager, Frank; Rosbach, Alla; Münch, Jürgen; Eschbach, Robert:

Inspection and Test Process Integration based on Explicit Test Prioritization Strategies. In: Biffel, Stefan (Ed.); Winkler, Dietmar (Ed.); Bergsmann, Johannes (Ed.): Software Quality: Process Automation in Software Development. 4th International Conference, SWQD 2012 - Proceedings. Berlin : Springer-Verlag, 2012, 181-192. (Lecture Notes in Business Information Processing 94). DOI http://dx.doi.org/10.1007/978-3-642-27213-4_12

Feth, Denis; Jung, Christian:

Context-Aware, Data-Driven Policy Enforcement for Smart Mobile Devices in Business Environments. In: Schmidt, Andreas (Ed.); Russello, Giovanni (Ed.); Krontiris, Ioannis (Ed.); Lian, Shiguo (Ed.): Security and Privacy in Mobile Information and Communication Systems. 4th International Conference. MobiSec 2012 - Revised Selected Papers. Berlin: Springer-Verlag, 2012, 69-80. (Lecture Notes of the Institute for Computer Sciences, Social Informatics and Telecommunications Engineering 107). DOI http://dx.doi.org/10.1007/978-3-642-33392-7_9

- Feth, Denis;** Pretschner, Alexander: Flexible Data-Driven Security for Android. In: IEEE Computer Society: 2012 IEEE Sixth International Conference on Software Security and Reliability (SERE) - Proceedings. Los Alamitos: IEEE Computer Society, 2012, 41-50. DOI <http://dx.doi.org/10.1109/SERE.2012.14>
- Frischbier, Sebastian; Gesmann, M.; Mayer, D.; Roth, A.; **Webel, Christian:** Emergence as Competitive Advantage: Engineering Tomorrow's Enterprise Software Systems. In: Maciaszek, L. (Ed.); Cuzocrea, A. (Ed.); Cordeiro, J. (Ed.): Proceedings of the 14th International Conference on Enterprise Information Systems. ICEIS 2012. Setubal: INSTICC, 2012, 181-186. DOI <http://dx.doi.org/10.5220/0003970501810186>
- Groß, Anne:** What do you expect from Requirements Specifications? An Empirical Investigation of Information Needs. In: Berntsson Svensson, Richard (Ed.); Berry, Daniel (Ed.); Daneva, Maya (Ed.); **Doerr, Joerg (Ed.);** Fricker, Samuel (Ed.); Herrmann, Andrea (Ed.); Herzwurm, Georg (Ed.); Kauppinen, Marjo (Ed.); Madhavji, Nazim H. (Ed.); Mahaux, Martin (Ed.); Paech, Barbara (Ed.); Penzenstadler, Birgit (Ed.); Pietsch, Wolfram (Ed.); Salinesi, Camille (Ed.); Schneider, Kurt (Ed.); Seyff, Norbert (Ed.); Weerd, Inge van de (Ed.); Universität Duisburg-Essen: 18th International Working Conference on Requirements Engineering: Foundation for Software Quality. Proceedings of the Workshops RE4SuSy, REEW, CreARE, RePriCo, IWSPM and the Conference Related Empirical Study, Empirical Fair and Doctoral Symposium. 2012, 314-315. (ICB Research Report 52).
- Groß, Anne; Doerr, Joerg:** What do Software Architects Expect from Requirements Specifications? Results of Initial Explorative Studies. In: IEEE Computer Society: First IEEE International Workshop on the Twin Peaks of Requirements and Architecture. TwinPeaks 2012 - Proceedings. Los Alamitos: IEEE Computer Society, 2012, 41-45. DOI <http://dx.doi.org/10.1109/TwinPeaks.2012.6344560>
- Groß, Anne; Doerr, Joerg:** What You Need Is What You Get! The Vision of View-Based Requirements Specifications. In: IEEE Computer Society: 20th IEEE International Requirements Engineering Conference. RE 2012 - Proceedings. Los Alamitos: IEEE Computer Society, 2012, 171-180. DOI <http://dx.doi.org/10.1109/RE.2012.6345801>
- Heidrich, Jens; Kowalczyk, Martin:** Tutorial: Business IT Alignment Using the GQM+Strategies® Approach. In: Dieste, Oscar (Ed.); **Jedlitschka, Andreas (Ed.);** Juristo, Natalia (Ed.): 13th International Conference on Product-Focused Software Process Improvement. PROFES'2012 - Proceedings. Berlin: Springer-Verlag, 2012, 370-373. (Lecture Notes in Computer Science 7343) DOI http://dx.doi.org/10.1007/978-3-642-31063-8_32
- Hess, Steffen; Jung, Jessica:** Does the iPad Add Value to Business Environments? In: Association for Computing Machinery (ACM): The 30th ACM Conference on Human Factors In Computing Systems (CHI). CHI 2012 - Extended Abstracts. New York: ACM Press, 2012, 335-350. DOI <http://dx.doi.org/10.1145/2212776.2212813>
- Hess, Steffen; Groß, Anne; Maier, Andreas;** Orfgen, Marius; Meixner, Gerrit: Standardizing Model-Based In-Vehicle Infotainment Development in the German Automotive Industry. In: Association for Computing Machinery (ACM): 4th International Conference on Automotive User Interfaces and Interactive Vehicular Applications. AutomotiveUI 2012 - Proceedings. New York: ACM Press, 2012, 59-66. DOI <http://dx.doi.org/10.1145/2390256.2390265>
- Keuler, Thorsten; Knodel, Jens; Naab, Matthias; Rost, Dominik:** Architecture Engagement Purposes: Towards a Framework for Planning "Just Enough"-Architecting in Software Engineering. In: Ali Babar, M. (Ed.); Cuesta, C. (Ed.); Savolainen, Juha Erik (Ed.); Männistö, T. (Ed.); IEEE Computer Society: 10th Joint Working Conference on Software Architecture WICSA and 6th European Conference on Software Architecture ECSA - Proceedings. Los Alamitos: IEEE Computer Society, 2012, 234-238. DOI <http://dx.doi.org/10.1109/WICSA-EC-SA.2012.36>
- Keuler, Thorsten;** Wagner, Stefan; Winkler, Bernhard: Architecture-aware Programming in Agile Environments. In: Ali Babar, M. (Ed.); Cuesta, C. (Ed.); Savolainen, Juha Erik (Ed.); Männistö, T. (Ed.); IEEE Computer Society: 10th Joint Working Conference on Software Architecture WICSA and 6th European Conference on Software Architecture ECSA - Proceedings. Los Alamitos: IEEE Computer Society, 2012, 229-233. DOI <http://dx.doi.org/10.1109/WICSA-EC-SA.2012.35>
- Wagner, Stefan; Lochmann, Klaus; Heinemann, Lars; **Klås, Michael; Trendowicz, Adam;** Plösch, Reinhold; Seidl, Andreas; Goeb, Andreas; Streit, Jonathan: The Quamoco Product Quality Modelling and Assessment Approach.

In: Glinz, Martin (Ed.); Murphy, Gail (Ed.); Pezze, Mauro (Ed.); IEEE Computer Society: 34th International Conference on Software Engineering. ICSE'2012 - Proceedings. 2012, 1133-1142.
DOI <http://dx.doi.org/10.1109/ICSE.2012.6227106>

Kleinberger, Thomas; Schuster, Mario; Bauer, Phillip; Chiriac, Sebastian; Hofmann, Cristian; Jalali Ghombovani, Lohrasb: Kompetenzplattform für die Entwicklung und Einführung von AAL-Lösungen.
In: Technik für ein selbstbestimmtes Leben. 5. Deutscher AAL-Kongress mit Ausstellung - Tagungsbeiträge. Berlin: VDE-VERLAG, 2012, 10 S.

Kowalczyk, Martin; Steinbach, Silke: Managing Process Model Compliance in Multi-Standard Scenarios Using a Tool-Supported Approach.
In: Dieste, Oscar (Ed.); **Jedlitschka, Andreas (Ed.);** Juristo, Natalia (Ed.): 13th International Conference on Product-Focused Software Process Improvement. PROFES'2012 - Proceedings. Berlin: Springer-Verlag, 2012, 355-360. (Lecture Notes in Computer Science 7343).
DOI http://dx.doi.org/10.1007/978-3-642-31063-8_28

Lampasona, Constanza; **Heidrich, Jens;** Basili, Victor R.; Ocampo, Alexis: Software Quality Modeling

Experiences at an Oil Company.
In: Association for Computing Machinery (ACM): ESEM 2012. Proceedings of the 2012 ACM-IEEE International Symposium on Empirical Software Engineering and Measurement. New York: ACM Press, 2012, 243-246.
DOI <http://dx.doi.org/10.1145/2372251.2372296>

Lampasona, Constanza; **Kläs, Michael:** Application Scenarios and Guidelines for Quality Model Adaptation.
In: Büren, Günter (Hrsg.); Dumke, Reiner (Hrsg.); Ebert, Christof (Hrsg.); **Münch, Jürgen (Hrsg.):** MetriKon 2012. Praxis der Software-Messung. Tagungsband des DASMA Software Metrik Kongresses. Aachen: Shaker, 2012, 3-18. (Magdeburger Schriften zum Empirischen Software Engineering)

Lampasona, Constanza; Rostanin, Oleg; Maus, Heiko: Seamless Integration of Order Processing in MS Outlook using SmartOffice: An Empirical Evaluation.
In: Association for Computing Machinery (ACM): ESEM 2012. Proceedings of the 2012 ACM-IEEE International Symposium on Empirical Software Engineering and Measurement. New York: ACM Press, 2012, 165-168.
DOI <http://dx.doi.org/10.1145/2372251.2372281>

Naab, Matthias; Stammel, Johannes: Architectural Flexibility in a Software-System's Life-Cycle: Systematic Construction and Exploitation of Flexibility.
In: Association for Computing Machinery (ACM): Proceedings of the 8th International ACM SIGSOFT Conference on the Quality of Software Architectures. QoSA'12. New York: ACM Press, 2012, 13-22.
DOI <http://dx.doi.org/10.1145/2304696.2304701>

Nakagawa, Elisa Yumi; **Becker, Martin;** Maldonado, José Carlos: A Knowledge-based Framework for Reference Architectures.
In: Association for Computing Machinery (ACM): Proceedings of the 27th Annual ACM Symposium on Applied Computing. New York: ACM Press, 2012, 1197-1202.
DOI <http://dx.doi.org/10.1145/2245276.2231964>

Nicolai, Simone; Storf, Holger; Fuchs, Anne-Marthe; Madler, Christian: Bedarfs- und Akzeptanzanalyse von AAL-Sensorik im Rahmen des Projektes "Pro-Assist4Life".
In: Technik für ein selbstbestimmtes Leben. 5. Deutscher AAL-Kongress mit Ausstellung - Tagungsbeiträge. Berlin: VDE-VERLAG, 2012, 4 S.

Patzke, Thomas; Becker, Martin; Steffens, Michaela; Sierszecki, Krzysztof; Savolainen, Juha Erik; Fogdal, Thomas: Identifying Improvement Potential in Evolving Product Line Infrastructures: 3 Case Studies.
In: Schwanninger, Christa (Ed.); Benavides, David (Ed.); Santos, Andre (Ed.); Alves, Vander (Ed.); Almeida, Eduardo Santana (Ed.); Association for Computing Machinery (ACM): 16th International Software Product Line Conference, SPLC 2012. Volume 1 - Proceedings. New York : ACM Press, 2012, 239-248.
DOI <http://dx.doi.org/10.1145/2362536.2362569>

Riegel, Norman: Model-Based Prioritization in Business-Process-Driven Software Development.
In: IEEE Computer Society: 20th IEEE International Requirements Engineering Conference. RE 2012 - Proceedings. Los Alamitos: IEEE Computer Society, 2012, 349-352.
DOI <http://dx.doi.org/10.1109/RE.2012.6345836>

Riegel, Norman; Doerr, Joerg; Hummel, Oliver: Tackling Prioritization in Business-Process-Driven Software Development.
In: Berntsson Svensson, Richard (Ed.); Berry, Daniel (Ed.); Daneva, Maya (Ed.); **Doerr, Joerg (Ed.);** Fricker, Samuel (Ed.); Herrmann, Andrea (Ed.); Herzwurm, Georg (Ed.); Kauppinen, Marjo (Ed.); Madhavji, Nazim H. (Ed.);

Mahaux, Martin (Ed.); Paech, Barbara (Ed.); Penzenstadler, Birgit (Ed.); Pietsch, Wolfram (Ed.); Salinesi, Camille (Ed.); Schneider, Kurt (Ed.); Seyff, Norbert (Ed.); Weerd, Inge van de (Ed.); Universität Duisburg-Essen: 18th International Working Conference on Requirements Engineering: Foundation for Software Quality. Proceedings of the Workshops RE4SuSy, REEW, CreaRE, RePriCo, IWSPM and the Conference Related Empirical Study, Empirical Fair and Doctoral Symposium. 2012, 175-180. (ICB Research Report 52).

Rost, Dominik:

Generation of Task-Specific Architecture Documentation for Developers. In: Association for Computing Machinery (ACM): WCOP 2012. Proceedings of the 17th International Doctoral Symposium on Components and Architecture. New York: ACM Press, 2012, 1-6. DOI <http://dx.doi.org/10.1145/2304676.2304678>

Rudolph, Manuel; Schwarz, Reinhard:

A Critical Survey of Security Indicator Approaches. In: IEEE Computer Society: Seventh International Conference on Availability, Reliability and Security. ARES 2012 - Proceedings. Los Alamitos: IEEE Computer Society, 2012, 291-300. DOI <http://dx.doi.org/10.1109/ARES.2012.10>

Storf, Holger; Schmitt, Mario; Arif, Taslim; Putz, Wolfgang; Eisenbarth, Michael; Uenalan, Oezguer:

Concept and Realization of an Individual Reminder Service for People Suffering from Dementia. In: Wichert, Reiner (Ed.); Laerhoven, Kristof van (Ed.); Gelissen, Jean (Ed.): Constructing Ambient Intelligence. Aml 2011 Workshops - Revised Selected Papers. Berlin: Springer-Verlag, 2012, 152-156. (Communications in Computer and Information Science 277). DOI http://dx.doi.org/10.1007/978-3-642-31479-7_23

Spitalewsky, Katharina; Ganzinger, Matthias; Kohl, Christian D.; **Storf, Holger**; Dickhaus, Hartmut; Knaup-Gregori, Petra: Erschließung von neuen Datenquellen für die medizinische Forschung aus AAL-Komponenten. In: Technik für ein selbstbestimmtes Leben. 5. Deutscher AAL-Kongress mit Ausstellung - Tagungsbeiträge. Berlin: VDE-VERLAG, 2012, 4 S.

Sit, Gee Fung; Shen, Chenbin; **Storf, Holger**; Hofmann, Cristian: Applikationsorientierte Fusion & Aggregation von Sensordaten. In: Technik für ein selbstbestimmtes Leben. 5. Deutscher AAL-Kongress mit Ausstellung - Tagungsbeiträge. Berlin: VDE-VERLAG, 2012, 7 S.

Villela, Karina; Arif, Taslim;

Zanardini, Damiano: Towards Product Configuration Taking into Account Quality Concerns. In: Schwanninger, Christa (Ed.); Benavides, David (Ed.); Santos, Andre (Ed.); Alves, Vander (Ed.); Almeida, Eduardo Santana (Ed.): Association for Computing Machinery (ACM): 16th International Software Product Line Conference, SPLC 2012. Volume 2 - Proceedings. New York: ACM Press, 2012, 82-89. DOI <http://dx.doi.org/10.1145/2364412.2364426>

Villela, Karina; Cohen, Sholom; Baresi, Luciano; Lee, Jaejoon; Schmid, Klaus:

SCArVeS: Services, Clouds, and Alternative Design Strategies for Variant-Rich Software Systems. In: Schwanninger, Christa (Ed.); Benavides, David (Ed.); Santos, Andre (Ed.); Alves, Vander (Ed.); Almeida, Eduardo Santana (Ed.): Association for Computing Machinery (ACM): 16th International Software Product Line Conference, SPLC 2012. Volume 1 - Proceedings. New York: ACM Press, 2012, S. 291. DOI <http://dx.doi.org/10.1145/2362536.2362579>

Zimmer, Bastian; Bürklen, Susanne; Höfflinger, Jens; **Trapp, Mario; Liggesmeyer, Peter:**

Safety-Focused Deployment Optimization in Open Integrated Architectures. In: Ortmeier, Frank (Ed.); Daniel, Peter (Ed.): Computer Safety, Reliability, and Security. 31st International Conference. SAFECOMP 2012 - Proceedings. Berlin: Springer-Verlag, 2012, 328-339. (Lecture Notes in Computer Science 7612). DOI http://dx.doi.org/10.1007/978-3-642-33678-2_28

Zimmermann, Fabian:

Distributed Code Review in Perl - State of the Practice. In: Proceedings YAPC: Europe 2012. 2012, 48-51.

Zhang, Bo; **Becker, Martin:** Code-based Variability Model Extraction for Software Product Line Improvement. In: Schwanninger, Christa (Ed.); Benavides, David (Ed.); Santos, Andre (Ed.); Alves, Vander (Ed.); Almeida, Eduardo Santana (Ed.): Association for Computing Machinery (ACM): 16th International Software Product Line Conference, SPLC 2012. Volume 2 - Proceedings. New York: ACM Press, 2012, 91-98. DOI <http://dx.doi.org/10.1145/2364412.2364428>

PROCEEDINGS BY EDITORS

Dieste, Oscar (Ed.); **Jedlitschka, Andreas** (Ed.); Juristo, Natalia (Ed.):
13th International Conference on Product-Focused Software Process Improvement. PROFES'2012 - Proceedings. (International Conference on Product-Focused Software Process Improvement <13, 2012, Berlin>) Berlin: Springer-Verlag, 2012. (Lecture Notes in Computer Science; 7343). ISBN 978-3-642-31062-1 ISSN 0302-9743. DOI <http://dx.doi.org/10.1007/978-3-642-31063-8>

Berntsson Svensson, Richard (Ed.); Berry, Daniel (Ed.); Daneva, Maya (Ed.); **Doerr, Joerg** (Ed.); Fricker, Samuel (Ed.); Herrmann, Andrea (Ed.); Herzwurm, Georg (Ed.); Kauppinen, Marjo (Ed.); Madhavji, Nazim H. (Ed.); Mahaux, Martin (Ed.); Paech, Barbara (Ed.); Penzenstadler, Birgit (Ed.); Pietsch, Wolfram (Ed.); Salinesi, Camille (Ed.); Schneider, Kurt (Ed.); Seyff, Norbert (Ed.); Weerd, Inge van de (Ed.); Universität Duisburg-Essen:
18th International Working Conference on Requirements Engineering: Foundation for Software Quality. Proceedings of the Workshops RE4SuSy, REEW, CreaRE, RePriCo, IWSPM and the Conference Related Empirical Study, Empirical Fair and Doctoral Symposium. (International

Working Conference on Requirements Engineering. Foundation for Software Quality <18, 2012, Essen>), (ICB Research Report; 52). ISSN 1860-2770 ISSN 1866-5101

FRAUNHOFER IESE REPORTS

Armbrust, Ove; **Kowalczyk, Martin**:
OPTIKON AP 3: Standardkonforme Prozessevolution. Kaiserslautern, 2012. (IESE-Report; 044.12/D)

Armbrust, Ove; **Kowalczyk, Martin; Steinbach, Silke; Zehler, Thomas**:
Schlussbericht für das Vorhaben OPTIKON - Optimierte Konfiguration normkonformer domänenspezifischer Prozesse für KMU. Kaiserslautern, 2012. (IESE-Report; 103.12/D)

Cronauer, Brian; Huber, Andreas; Höh, Michael; **Keuler, Thorsten**:
Agile Doesn't Scale ... Without Architecture. Kaiserslautern, 2012. (IESE-Report; 028.12/E)

Dubinsky, Yael; Rubin, Julia; Berger, Thorsten; **Duszynski, Slawomir; Becker, Martin**; Czarnecki, Krzysztof:
An Exploratory Study of Cloning in Industrial Software Product Lines. Kaiserslautern, 2012. (IESE-Report; 113.12/E)

Dubois, Hubert; Ibanez, Vincent; Lopez, Cristina; Machrouh, Joseph; Meledo, Nicolas; Mouy, Patricia; **Silva, Adeline de Sousa**:
The product line engineering approach in a model-driven process. Kaiserslautern, 2012. (IESE-Report; 021.12/E)

Duszynski, Slawomir; Becker, Martin:
Recovering Variability Information from the Source Code of Similar Software Products. Kaiserslautern, 2012. (IESE-Report; 038.12/E)

Duszynski, Slawomir; Becker, Martin; Kalmar, Ralf:
Variantenanalyse - Wiederverwendungspotenzial auf Basis einer Quellcodeanalyse. Kaiserslautern, 2012. (IESE-Report; 114.12/D)

Elberzhager, Frank; Bauer, Thomas:
From Assumptions to Context-specific Knowledge in the Area of Combined Static and Dynamic Quality Assurance. Kaiserslautern, 2012. (IESE-Report; 094.12/E)

Elberzhager, Frank; Kremer, Stephan; Münch, Jürgen; Assmann, Danilo:
Guiding Testing Activities by Predicting Defect-prone Parts Using Product and Inspection Metrics. Kaiserslautern, 2012. (IESE-Report; 095.12/E)

Elberzhager, Frank; Münch, Jürgen; Rombach, H. Dieter; Freimut, Bernd:
Integrating Inspection and Test Processes based on Context-Specific Assumptions. Kaiserslautern, 2012. (IESE-Report; 093.12/E)

Elberzhager, Frank; Rombach, Alla; Münch, Jürgen; Eschbach, Robert:
Reducing test effort: A systematic mapping study on existing approaches. Kaiserslautern, 2012. (IESE-Report; 057.12/E)

- Feth, Denis; Jung, Christian:**
Context-Aware, Data-Driven Policy Enforcement for Smart Mobile Devices in Business Environments.
Kaiserslautern, 2012.
(IESE-Report; 071.12/E)
- Feth, Denis;** Pretschner, Alexander:
Flexible Data-Driven Security for Android.
Kaiserslautern, 2012.
(IESE-Report; 070.12/E)
- Groß, Anne; Doerr, Joerg:**
Investigating Information Needs - Elicitation Guidelines.
Kaiserslautern, 2012.
(IESE-Report; 033.12/E)
- Heidrich, Jens:**
Specula Project Support Environment (PSE) Open Source Software.
Kaiserslautern, 2012.
(IESE-Report; 061.11/E)
- Herrmann, Andrea; Daneva, Maya; **Doerr, Joerg;** Schneider, Kurt:
2nd International Workshop on Creativity in Requirements Engineering - CreaRE 2012.
Kaiserslautern, 2012.
(IESE-Report; 072.12/E)
- Hess, Steffen; Jung, Jessica:**
Does the iPad Add Value to Business Environments?
Kaiserslautern, 2012.
(IESE-Report; 058.12/E)
- Hess, Steffen; Kiefer, Felix; Carbon, Ralf; Maier, Andreas:**
mConcAppt - A Method for the Conception of Mobile Business Applications.
Kaiserslautern, 2012.
(IESE-Report; 098.12/E)
- Hess, Steffen; Kiefer, Felix:**
mConcAppt Methode. UX und Interaktionsdesign für mobile Business Apps.
Kaiserslautern, 2012.
(IESE-Report; 099.12/D)
- Hess, Steffen; Kiefer, Felix; Carbon, Ralf:**
Quality by Construction through mConcAppt. Towards Using UI-Construction as Driver for High Quality Mobile App Engineering.
Kaiserslautern, 2012.
(IESE-Report; 101.12/E)
- Jedlitschka, Andreas; Hack, Marco; Flick, Simone:**
MUNDUS Environmental Sensor Framework.
Kaiserslautern, 2012.
(IESE-Report; 077.12/E)
- Jung, Christian; Elberzha-ger, Frank;** Bagnato, Alessandra; Raiteri, Fabio:
Creating and Applying Security Goal Indicator Trees in an Industrial Environment.
Kaiserslautern, 2012.
(IESE-Report; 049.12/E)
- Keuler, Thorsten; Antonino, Pablo:**
SysML-basierte Anforderungsmodellierung - Model-checking als "Blackbox".
Kaiserslautern, 2012.
(IESE-Report; 011.12/D)
- Keuler, Thorsten; Knodel, Jens; Naab, Matthias; Rost, Dominik:**
Architecture Engagement Purposes: Towards a Framework for Planning "Just Enough"-Architecting in Software Engineering.
Kaiserslautern, 2012.
(IESE-Report; 096.12/E)
- Kläs, Michael; **Lampasona, Constanza;** Becker, Franz; Göddel, Jens:
Source Code für Assistenten zur Anpassung von Qualitätsmodellen und zur Erstellung und Bearbeitung von Bewertungsvorschriften.
Kaiserslautern, 2012.
(IESE-Report; 098.11/D)
- Kleinberger, Thomas;** Schuster, Mario; Bauer, Philipp; Chiriac, Sebastian; Hofmann, Cristian; Jalali Ghombovani, Lohrasb:
Kompetenzplattform für die Entwicklung und Einführung von AAL-Lösungen.
Kaiserslautern, 2012.
(IESE-Report; 018.12/D)
- Knaup-Gregori, Petra; Schöpe, Lothar; Demski, Hans; Ganzinger, Matthias; Hannig, Rüdiger; Helmer, Axel; Jankowski, Anna; Kraft, Andreas; Kolly, Laurent; Kröger, Reinhold; Plischke, Maik; Schäfer, Jan; Schöchlin, Jürgen; Soltani, Nazli; Spitalewsky, Katharina; Stiller, Carsten; **Storf, Holger;** Thoss, Marcus; Ulrich, Siegfried:
Von eingebetteten zu soziotechnischen Systemen. Potenzial und Forschungsbedarf auf dem Gebiet der IT im AAL-Umfeld.
Kaiserslautern, 2012.
(IESE-Report; 025.12/D)
- Kowalczyk, Martin; Barthel, Henning; Münch, Jürgen; Heidrich, Jens; Trendowicz, Adam:**
A Deployment Process for Strategic Measurement Systems.
Kaiserslautern, 2012.
(IESE-Report; 023.11/E)
- Kowalczyk, Martin; Steinbach, Silke:**
Managing Process Model Compliance in Multi-Standard Scenarios Using a Tool-Supported Approach.
Kaiserslautern, 2012.
(IESE-Report; 052.12/E)
- Lampasona, Constanza:**
Umfrage SPES2020: Relevanz, Zukunft und Stellenwert modellbasierter Softwareentwicklung.
Kaiserslautern, 2012.
(IESE-Report; 086.12/D)
- Lampasona, Constanza;** Rostanin, Oleg; Maus, Heiko:
Seamless Integration of Order Processing in MS Outlook using SmartOffice: An Empirical Evaluation.
Kaiserslautern, 2012.
(IESE-Report; 087.12/E)
- Lampasona, Constanza; Heidrich, Jens;** Basili, Victor R.; Ocampo, Alexis:
Software Quality Modeling Experiences at an Oil Company.
Kaiserslautern, 2012.
(IESE-Report; 085.12/E)
- Lampasona, Constanza; Kläs, Michael:**
Application Scenarios and Guidelines for Quality Model Adaptation.
Kaiserslautern, 2012.
(IESE-Report; 102.12/E)
- Lampasona, Constanza; Kläs, Michael;** Plösch, Reinhold:
Variability and Tailoring Mechanisms for Quality Models.
Kaiserslautern, 2012.
(IESE-Report; 035.12/E)

Lampasona, Constanza; Kläs, Michael; Plösch, Reinhold:
Selection Criteria and Process for Quality Model Tailoring. Kaiserslautern, 2012. (IESE-Report; 034.12/E)

Lampasona, Constanza; Rostanin, Oleg; Maus, Heiko:
Seamless Integration of Order Processing in MS Outlook using SmartOffice: An Empirical Evaluation. Kaiserslautern, 2012. (IESE-Report; 087.12/E)

Liggesmeyer, Peter; Bomarius, Frank; Kalmar, Ralf:
Eingebettete, vernetzte Systeme: Die Basis für systemweite Energieeffizienz. Kaiserslautern, 2012. (IESE-Report; 003.12/D)

Luiz, Thomas; Lengen, Rolf van:
Informationstechnologie in der Notfallmedizin. Kaiserslautern, 2012. (IESE-Report; 017.12/D)

Moucha, Cornelius; Lovat, Enrico; Pretschner, Alexander:
A virtualized usage control bus system. Kaiserslautern, 2012. (IESE-Report; 042.12/E)

Naab, Matthias:
Experiment on Explicit Modeling of Change Impact Views: Experiment Material and Data. Kaiserslautern, 2012. (IESE-Report; 031.12/E)

Naab, Matthias; Keuler, Thorsten; Knodel, Jens:
"Architektur - für wen, was, wann, und wie viel?". Kaiserslautern, 2012. (IESE-Report; 092.12/D)

Naab, Matthias; Stammel, Johannes:
Architectural Flexibility in a Software-System's Life-Cycle: Systematic Construction and Exploitation of Flexibility. Kaiserslautern, 2012. (IESE-Report; 055.12/E)

Nakagawa, Elisa Yumi; **Antonino, Pablo; Becker, Martin;** Maldonado, José Carlos; **Storf, Holger; Villela, Karina; Rombach, H. Dieter:**
Relevance and Perspectives of AAL in Brazil. Kaiserslautern, 2012. (IESE-Report; 073.12/E)

Nakagawa, Elisa Yumi; **Becker, Martin;** Maldonado, José Carlos:
A Knowledge-based Framework for Reference Architectures. Kaiserslautern, 2012. (IESE-Report; 006.12/E)

Neisse, Ricardo; Pretschner, Alexander; Giacomo, Valentina Di:
A Trustworthy Usage Control Enforcement Framework. Kaiserslautern, 2012. (IESE-Report; 029.12/E)

Nunnenmacher, Sabine; **Jung, Jessica;** Chehrazi, Golriz; **Klaus, Alexander; Lampasona, Constanza; Webel, Christian; Ciolkowski, Marcus:**
A Preliminary Survey on Subjective Measurements and Personal Insights into Factors of Perceived Future Project Success. Kaiserslautern, 2012. (IESE-Report; 030.12/E)

Oliveira Albuquerque, Caroline; **Antonino, Pablo;** Nakagawa, Elisa Yumi:
An Investigation into Agile Methods in Embedded Systems Development. Kaiserslautern, 2012. (IESE-Report; 050.12/E)

Rombach, H. Dieter; Storf, Holger; Kleinberger, Thomas:
Situation-of-Helplessness Detection System for Senior Citizens. Kaiserslautern, 2012. (IESE-Report; 010.12/E)

Rost, Dominik:
Generation of Task-Specific Architecture Documentation for Developers. Kaiserslautern, 2012. (IESE-Report; 063.12/E)

Rudolph, Manuel; Schwarz, Reinhard:
A Critical Survey of Security Indicator Approaches. Kaiserslautern, 2012. (IESE-Report; 044.12/E)

Rudolph, Manuel; Schwarz, Reinhard:
Security Indicators - A State of the Art Survey Public Report. Kaiserslautern, 2012. (IESE-Report; 043.12/E)

Schäfer, Christian; Kuhn, Thomas; Trapp, Mario:
A Pattern-based Approach to DSL Development. Kaiserslautern, 2012. (IESE-Report; 007.12/E)

Schlosser, Simon:
Tool-support for perspective-based views on software requirements documents. Kaiserslautern, 2012. (IESE-Report; 032.12/E)

Silva, Adeline de Sousa; Becker, Martin; Schmidt, Rainer; Graubmann, Peter; Meledo, Nicolas; Ibanez, Vincent:
Theory and Application of Product Line Engineering. Kaiserslautern, 2012. (IESE-Report; 020.12/E)

Sit, Gee Fung; Shen, Chenbin; **Storf, Holger;** Hofmann, Cristian:
Applikationsorientierte Fusion & Aggregation von Sensordaten. Kaiserslautern, 2012. (IESE-Report; 022.12/D)

Spitalewsky, Katharina; Ganzinger, Matthias; Kohl, Christian D.; **Storf, Holger;** Dickhaus, Hartmut; Knaup-Gregori, Petra:
Erschließung von neuen Datenquellen für die medizinische Forschung aus AAL-Komponenten. Kaiserslautern, 2012. (IESE-Report; 023.12/D)

Steinbach, Silke; Heintz, Matthias; Weber, Sebastian; Trapp, Sonja; Kerkow, Daniel:
Innovative Technologien für Seniorinnen und Senioren in Rheinland-Pfalz. Gutachten für die Zentralstelle für IT und Multimedia ISM. Kaiserslautern, 2012. (IESE-Report; 059.11/D)

Storf, Holger:
Die intelligente Wohnung - Altersgerechte Assistenzsysteme. Kaiserslautern, 2012. (IESE-Report; 009.12/D)

Storf, Holger; Schmitt, Mario; Arif, Taslim; Putz, Wolfgang; Eisenbarth, Michael; Uenal, Oezguer:

Concept and Realization of an Individual Reminder Service for People Suffering from Dementia.

Kaiserslautern, 2012.
(IESE-Report; 008.12/E)

Tenev, Vasil; Duszynski, Slawomir:

Applying Bioinformatics in the Analysis of Software Variants.

Kaiserslautern, 2012.
(IESE-Report; 053.12/E)

Trendowicz, Adam; Kläs, Michael:

A Framework for Maintaining Software Quality Models.

Kaiserslautern, 2012.
(IESE-Report; 015.12/E)

Trendowicz, Adam; Kläs, Michael:

SQUAD - The Software Quality Assessment Method.

Kaiserslautern, 2012.
(IESE-Report; 016.12/E)

Trendowicz, Adam; Kläs, Michael; Lampasona, Constanza; Münch, Jürgen;

Körner, Christian; Saft, Matthias:

Model-based Product Quality Evaluation with Multi-Criteria Decision Analysis.

Kaiserslautern, 2012.
(IESE-Report; 033.11/E)

Villela, Karina; Arif, Taslim; Zanardini, Damiano:

Towards Product Configuration Taking into Account Quality Concerns.

Kaiserslautern, 2012.
(IESE-Report; 088.12/E)

Weitzel, Balthasar:

Towards Transparent Architectural Decisions for Software Deployment.

Kaiserslautern, 2012.
(IESE-Report; 107.12/E)

Weitzel, Balthasar:

Understanding Deployment Costs of Enterprise Systems Towards architecture support in deployment decisions.

Kaiserslautern, 2012.
(IESE-Report; 108.12/E)

Zimmermann, Fabian:

Distributed Code Review in Perl - State of the Practice.

Kaiserslautern, 2012.
(IESE-Report; 089.12/E)

OTHER TECHNICAL REPORTS

Lampasona, Constanza;
Bundesministerium für Bildung und Forschung (BMBF):
Umfrage SPES2020: Relevanz, Zukunft und Stellenwert modellbasierter Softwareentwicklung.
2012.

DOCTORAL THESES

Carbon, Ralf:

Architecture-Centric Software Producibility Analysis.

Rombach, H. Dieter (Advisor); Reussner, Ralf H. (Advisor)

Stuttgart: Fraunhofer Verlag, 2012

(PhD Theses in Experimental Software Engineering; Vol. 38).

Zugl.: Kaiserslautern, Techn. Univ., Diss., 2011

ISBN 978-3-8396-0372-7

Elberzhager, Frank:

A Systematic Integration of Inspection and Testing Processes for Focusing Testing Activities.

Rombach, H. Dieter (Advisor); **Münch, Jürgen** (Advisor); Zellner, Andreas (Advisor)

Stuttgart: Fraunhofer Verlag, 2012

(PhD Theses in Experimental Software Engineering; Vol. 40).

Zugl.: Kaiserslautern, Techn. Univ., Diss., 2012

ISBN 978-3-8396-0445-8

Neisse, Ricardo:

University of Twente - Centre for Telematics and Information Technology: Trust and privacy management support for context-aware service platforms.

Wieringa, R. J. (Advisor);

Singeren, M. J. van (Advisor);

Wegdam, M. (Advisor)

Twente, 2012

(CTIT Ph.D. Thesis Series; 11-216). (SIKS Dissertation Series; 2012-09).

Zugl.: Twente, Univ., Diss., 2012

ISBN 978-90-365-3336-2

DOI <http://dx.doi.org/10.3990/1.9789036533362>

Schmidt, Florian:

Funktionale Absicherung kamerabasierter Aktiver Fahrerassistenzsysteme durch Hardware-in-the-Loop-Tests.

Liggesmeyer, Peter (Advisor); Müller-Glaser, Klaus (Advisor)

Stuttgart: Fraunhofer Verlag, 2012

(PhD Theses in Experimental Software Engineering; Vol. 39).

Zugl.: Kaiserslautern, Techn. Univ., Diss., 2012

ISBN 978-3-8396-0389-5

MASTER'S THESES

Diebold, Philipp; Rombach, H. Dieter (Supervisor);

Jedlitschka, Andreas (IESE Advisor):

A Framework for Goal-oriented Process Configuration.

Context-Specific Configuration of SE Processes in SPEM. Kaiserslautern, 2012. Kaiserslautern, Techn. Univ., Master's Thesis, 2012

Gomes, Mateus; Rombach, H. Dieter (Supervisor);

Keuler, Thorsten (IESE Advisor): Interactive Model Exploration Using Meta Types and Reflection.

Kaiserslautern, 2012. Kaiserslautern, Techn. Univ., Master's Thesis, 2012

Granado, Lihér; Etxeberria, Leire (Supervisor); **Knodel, Jens** (IESE Advisor); **Weitzel, Balthasar** (IESE Advisor):

A Framework for Visualizing the Evolution of Software Architecture Analysis Attributes.

Kaiserslautern, 2012. Mon-dragon University, Master's Thesis, 2012

Kremer, Stephan; Rombach, H. Dieter (Supervisor);

Liggesmeyer, Peter (Supervisor); **Elberzhager, Frank** (IESE Advisor):

Optimizing quality assurance activities by considering metrics and context factors.

Kaiserslautern, 2012. Kaiserslautern, Techn. Univ., Master's Thesis, 2012

Seise, Christian; Rombach, H. Dieter (Supervisor);

Liggesmeyer, Peter (Supervisor); **Jung, Christian** (IESE Advisor):

A Context-aware Extension of Usage Control for the Android OS.

Kaiserslautern, 2012. Kaiserslautern, Techn. Univ., Master's Thesis, 2012

BACHELOR'S THESES

Hupp, Steffen; Rombach, H. Dieter (Supervisor);

Lampasona, Constanza (IESE Advisor):

How to Achieve and Measure Quality in Multi-Core Systems.

Kaiserslautern, 2012. Kaiserslautern, Techn. Univ., Bachelor's Thesis, 2012

Lutsch, Sebastian; Rombach, H. Dieter (Supervisor);

Lampasona, Constanza (IESE Advisor):

Quality Factors Driving Costs In Multi-Core Systems.

Kaiserslautern, 2012. Kaiserslautern, Techn. Univ., Bachelor's Thesis, 2012

Scherr, Simon André; Rombach, H. Dieter (Supervisor);

Lampasona, Constanza (IESE Advisor):

Quality Measurement in the Field of Multi Core Systems.

Kaiserslautern, 2012. Kaiserslautern, Techn. Univ., Bachelor's Thesis, 2012

AWARDS

INTERNAL AWARDS

Thomas Jeswein
The Fraunhofer IESE Award
2012 for Project Excellence

Kai Simon
The Fraunhofer IESE Award
2012 for Project Excellence

Dennis Landmann
The Fraunhofer IESE Award
2012 for Project Excellence

Daniel Schneider
The Fraunhofer IESE Award
2012 for Research Excellence

Anne Heß
The Fraunhofer IESE Award
2012 for Empirical Excellence

**Mateus Volkmer Nunes
Gomes**
The Fraunhofer IESE Award
2012 for Master Thesis Excel-
lence

Philipp Diebold
The Fraunhofer IESE Award
2012 for Master Thesis Excel-
lence

Michael Schneck
The Fraunhofer IESE Award
2012 for Infrastructure Excel-
lence

Ulla Michel
The Fraunhofer IESE Award
2012 for Infrastructure Excel-
lence

EXTERNAL AWARDS

Vasil L. Tenev, **Slawomir
Duszynski**
Best Poster Paper Award,
20th IEEE International
Conference on Program
Comprehension (ICPC
2012), Passau, Germany,
June 11-13, 2012

Thomas Jeswein
dbb Innovationspreis 2012 -
P23R, dbb, Berlin, Germany,
October 15, 2012

Norman Riegel
dbb Innovationspreis 2012 -
P23R, dbb, Berlin, Germany,
October 15, 2012

Christian Seise
5th Place, CAST Award
(Master's Thesis), CAST e. V./
Gesellschaft für Informatik
e.V., Darmstadt, Germany,
November 23, 2012